



TEST REPORT



Applicant	Shenzhen SOFAR SOLAR Co., Ltd.
Address	401, Building 4, AnTongDa Industrial Park, District 68, XingDong Community, XinAn Street, BaoAn District, Shenzhen, China.

Manufacturer or Supplier	Shenzhen SOFAR SOLAR Co., Ltd.	
Address	401, Building 4, AnTongDa Industrial Park, District 68, XingDong Community, XinAn Street, BaoAn District, Shenzhen, China.	
Product	Hybrid Inverter	
Brand Name		
Model	HYD 10KTL-3PH, HYD 20KTL-3PH	
Additional Model & Model Difference	HYD 15KTL-3PH, See items 2.1	
Date of tests	May 08, 2020 ~ May 22, 2020	

The submitted sample of the above equipment has been tested according to the requirements of the following standards:

- EN 61000-6-3:2007+A1:2011+AC:2012
- EN 61000-3-12:2011
- EN 61000-3-11:2000
- EN IEC 61000-3-2:2019
- EN 61000-3-3:2013+A1:2019
- EN 61000-6-2:2005

CONCLUSION: The submitted sample was found to COMPLY with the test requirement

Tested by Ryan Lu Project Engineer / EMC Department	Approved by Madison Luo Assistant Manager / EMC Department
	 Date: May 25, 2020

This report is governed by, and incorporates by reference, CPS Conditions of Service as posted at the date of issuance of this report at <http://www.bureauveritas.com/home/about-us/our-business/cps/about-us/terms-conditions/> and is intended for your exclusive use. Any copying or replication of this report to or for any other person or entity, or use of our name or trademark, is permitted only with our prior written permission. This report sets forth our findings solely with respect to the test samples identified herein. The results set forth in this report are not indicative or representative of the quality or characteristics of the lot from which a test sample was taken or any similar or identical product unless specifically and expressly noted. Our report includes all of the tests requested by you and the results thereof based upon the information that you provided to us. Measurement uncertainty is only provided upon request for accredited tests. You have 60 days from date of issuance of this report to notify us of any material error or omission caused by our negligence or if you require measurement uncertainty; provided, however, that such notice shall be in writing and shall specifically address the issue you wish to raise. A failure to raise such issue within the prescribed time shall constitute you unqualified acceptance of the completeness of this report, the tests conducted and the correctness of the report contents.



Table of Contents

RELEASE CONTROL RECORD 5

1 SUMMARY OF TEST RESULTS 6

1.1 MEASUREMENT UNCERTAINTY 8

2 GENERAL INFORMATION 9

2.1 GENERAL DESCRIPTION OF EUT 9

2.2 DESCRIPTION OF TEST MODES 10

2.3 GENERAL DESCRIPTION OF APPLIED STANDARDS 12

2.4 DESCRIPTION OF SUPPORT UNITS 12

3 EMISSION TEST 13

3.1 CONDUCTED EMISSION MEASUREMENT 13

3.1.1 LIMITS OF CONDUCTED EMISSION MEASUREMENT 13

3.1.2 TEST INSTRUMENTS 13

3.1.3 TEST PROCEDURE 14

3.1.4 DEVIATION FROM TEST STANDARD 14

3.1.5 TEST SETUP 15

3.1.6 EUT OPERATING CONDITIONS 15

3.1.7 TEST RESULTS 16

3.2 RADIATED EMISSION MEASUREMENT 20

3.2.1 LIMITS OF RADIATED EMISSION MEASUREMENT 20

3.2.2 TEST INSTRUMENTS 21

3.2.3 TEST PROCEDURE 22

3.2.4 DEVIATION FROM TEST STANDARD 23

3.2.5 TEST SETUP 24

3.2.6 EUT OPERATING CONDITIONS 24

3.2.7 TEST RESULTS 25

3.3 HARMONICS CURRENT MEASUREMENT 27

3.3.1 LIMITS OF HARMONICS CURRENT MEASUREMENT 27

3.3.2 CURRENT EMISSION LIMITS FOR EQUIPMENT OTHER THAN
BALANCED THREE-PHASE EQUIPMENT 27

3.3.3 CURRENT EMISSION LIMITS FOR BALANCED THREE-PHASE
EQUIPMENT 28

3.3.4 CURRENT EMISSION LIMITS FOR BALANCED THREE-PHASE
EQUIPMENT UNDER SPECIFIED CONDITIONS 28

3.3.5 DEVIATION FROM TEST STANDARD 29

3.3.6 TEST SETUP 29

3.3.7 EUT OPERATING CONDITIONS 29

3.3.8 TEST RESULTS 30

3.4 VOLTAGE FLUCTUATION AND FLICKS MEASUREMENT 39

3.4.1 LIMITS OF VOLTAGE FLUCTUATION AND FLICKS MEASUREMENT 39

3.4.2 TEST INSTRUMENTS 40

3.4.3 TEST PROCEDURE 40

3.4.4 DEVIATION FROM TEST STANDARD 41

3.4.5 TEST SETUP 41



3.4.6 EUT OPERATING CONDITIONS41

3.4.7 TEST RESULTS42

4 IMMUNITY TEST 46

4.1 GENERAL DESCRIPTION46

4.1.1 GENERAL DESCRIPTION OF EN 61000-6-146

4.1.2 PERFORMANCE CRITERIA47

4.1.3 EUT OPERATING CONDITION47

4.2 ELECTROSTATIC DISCHARGE IMMUNITY TEST (ESD)48

4.2.1 TEST SPECIFICATION48

4.2.2 TEST INSTRUMENTS48

4.2.3 TEST PROCEDURE49

4.2.4 DEVIATION FROM TEST STANDARD49

4.2.5 TEST SETUP50

4.2.6 TEST RESULTS51

4.3 RADIATED, RADIO-FREQUENCY, ELECTROMAGNETIC FIELD53

IMMUNITY TEST (RS)53

4.3.1 TEST SPECIFICATION53

4.3.2 TEST INSTRUMENTS53

4.3.3 TEST PROCEDURE54

4.3.4 DEVIATION FROM TEST STANDARD54

4.3.5 TEST SETUP55

4.3.6 TEST RESULTS56

4.4 ELECTRICAL FAST TRANSIENT/BURST IMMUNITY TEST (EFT)57

4.4.1 TEST SPECIFICATION57

4.4.2 TEST INSTRUMENTS57

4.4.3 TEST PROCEDURE57

4.4.4 DEVIATION FROM TEST STANDARD57

4.4.5 TEST SETUP58

4.4.6 TEST RESULTS59

4.5 SURGE IMMUNITY TEST60

4.5.1 TEST SPECIFICATION60

4.5.2 TEST INSTRUMENTS60

4.5.3 TEST PROCEDURE61

4.5.4 DEVIATION FROM TEST STANDARD61

4.5.5 TEST SETUP61

4.5.6 TEST RESULTS62

4.6 IMMUNITY TO CONDUCTED DISTURBANCES INDUCED BY RF63

FIELDS (CS)63

4.6.1 TEST SPECIFICATION63

4.6.2 TEST INSTRUMENTS63

4.6.3 TEST PROCEDURE64

4.6.4 DEVIATION FROM TEST STANDARD64

4.6.5 TEST SETUP65

4.6.6 TEST RESULTS66

4.7 POWER FREQUENCY MAGNETIC FIELD IMMUNITY TEST67

4.7.1 TEST SPECIFICATION67

4.7.2 TEST INSTRUMENTS67

4.7.3 TEST PROCEDURE67



Test Report No.: CE200409N067

4.7.4	DEVIATION FROM TEST STANDARD.....	67
4.7.5	TEST SETUP.....	68
4.7.6	TEST RESULTS	69
5	PHOTOGRAPHS OF THE TEST CONFIGURATION	70
6	APPENDIX A – MODIFICATIONS RECORDERS FOR ENGINEERING CHANGES TO THE EUT BY THE LAB	76



**BUREAU
VERITAS**

Test Report No.: CE200409N067

RELEASE CONTROL RECORD

ISSUE NO.	REASON FOR CHANGE	DATE ISSUED
CE200409N067	Original release	May 25, 2020



1 SUMMARY OF TEST RESULTS

The EUT has been tested according to the following specifications:

EMISSION			
Standard	Test Type	Result	Remark
EN61000-6-3:2007+A1: 2011+AC:2012	Conducted test	PASS	Meets Limits Minimum passing margin is -1.88 dB at 0.15781 MHz
	Radiated test (30MHz~1GHz)	PASS	Meets limits minimum passing margin is -3.03 dB at 145.6298 MHz
EN 61000-3-12:2011	Harmonic current emissions	PASS	Meets the requirements.
EN 61000-3-11:2001	Voltage fluctuations & flicker	PASS	Meets the requirements.
EN IEC 61000-3-2:2019	Harmonic current emissions	PASS	Meets the requirements.
EN 61000-3-3:2013+A1:2019	Voltage fluctuations & flicker	PASS	Meets the requirements.



IMMUNITY (EN 61000-6-2:2005)			
Standard	Test Type	Result	Remark
IEC 61000-4-2:2008 ED. 2.0	Electrostatic discharge immunity test	PASS	Electrostatic Discharge – ESD: 8kV Air discharge, 4kV Contact discharge, Performance Criterion A
IEC 61000-4-3:2010 ED. 3.2	Radiated, radio-frequency, electromagnetic field immunity test	PASS	Radio-Frequency Electromagnetic Field Susceptibility Test – RS: 80-1000 MHz, 10V/m, 80% AM (1kHz), 1400-2000 MHz, 3V/m, 80% AM (1kHz) 2000-2700 MHz, 1V/m, 80% AM (1kHz) Performance Criterion A
IEC 61000-4-4:2012 ED. 3.0	Electrical fast transient / burst immunity test.	PASS	Electrical Fast Transient/Burst - EFT AC Power line: 2kV, DC Power line: 2kV, Performance Criterion A
IEC 61000-4-5:2017 ED. 3.1	Surge immunity test	PASS	Surge Immunity Test: 1.2/50 us Open Circuit Voltage, 8 /20 us Short Circuit Current, AC Power Line: line to line 1 kV, line to earth 2kV DC Power Line: line to line 0.5kV Performance Criterion A
IEC 61000-4-6:2013 ED. 4.0	Immunity to conducted disturbances, induced by radio-frequency fields	PASS	Conducted Radio Frequency Disturbances Test – CS: 0.15-80 MHz, 3Vrms, 80% AM, 1kHz, Performance Criterion A
IEC 61000-4-8:2009 ED. 2.0	Power frequency magnetic field immunity test.	PASS	Power Frequency Magnetic Field Test, 50/60Hz, 30A/m, Performance Criterion A



1.1 MEASUREMENT UNCERTAINTY

Where relevant, the following measurement uncertainty levels have been estimated for tests performed on the EUT as specified in CISPR 16-4-2:

This uncertainty represents an expanded uncertainty expressed at approximately the 95% confidence level using a coverage factor of $k=2$.

MEASUREMENT	FREQUENCY	UNCERTAINTY
Mains Terminal Disturbance Voltage Test	0.15MHz ~ 30MHz	+ /-2.70 dB
Radiated Disturbance Test	30MHz ~ 1000MHz	+ /-3.99 dB



2 GENERAL INFORMATION

2.1 GENERAL DESCRIPTION OF EUT

PRODUCT	Hybrid Inverter
MODEL NO.	HYD 10KTL-3PH, HYD 20KTL-3PH
ADDITIONAL MODEL	HYD 15KTL-3PH
POWER SUPPLY	DC Input: 200-900V 50A max AC Output: 400V or 380V Battery port input/output: DC 200-750V
THE HIGHEST OPERATING FREQUENCY	Below 108MHz
CABLE SUPPLIED	N/A

NOTE:

1. For the test results, the EUT had been tested with all conditions. But only the worst case was showed in test report.
2. For a more detailed features description, please refer to the manufacturer's specifications or the User's Manual.
3. Please refer to the EUT photo document (Reference No.: 200409N067-1) for detailed product photo.
4. Additional model HYD 15KTL-3PH is identical with test model HYD 20KTL-3PH except the output power.
5. WIFI module of all models are optional accessories, optional installation according to the need of client.
6. Test model HYD 10KTL-3PH and HYD 20KTL-3PH are identical except the inverter inductance and output power, the difference has been considered during this test, full test was performed for the model HYD 20KTL-3PH and partial test for the model HYD 10KTL-3PH test CE, RE, H&F.
7. The output current of model HYD 10KTL-3PH is less than 16A and HYD 10KTL-3PH, HYD 20KTL-3PH are greater than 16A.



2.2 DESCRIPTION OF TEST MODES

The EUT were tested under the following modes, the final worst mode was marked in boldface and recorded in this report.

CONDUCTED EMISSION TEST:

Test Mode	Test Model	Test Voltage
Grid Mode (Full load)	HYD 20KTL-3PH	Input 450VDC Output 400VAC 50Hz Input 650VDC Output 400VAC 50Hz Input 850VDC Output 400VAC 50Hz
Grid+battery charging		Input 450VDC Output 400VAC 50Hz
Grid+battery discharging		Input 450VDC Output 400VAC 50Hz
Battery charging		Input AC 400V 50Hz
Grid Mode (Full load)	HYD 10KTL-3PH	Input 250VDC Output 400VAC 50Hz Input 550VDC Output 400VAC 50Hz Input 850VDC Output 400VAC 50Hz
Grid+battery charging		Input 250VDC Output 400VAC 50Hz
Grid+battery discharging		Input 250VDC Output 400VAC 50Hz
Battery charging		Input AC 400V 50Hz

RADIATED EMISSION TEST:

Test Mode	Test Model	Test Voltage
Grid Mode (Full load)	HYD 20KTL-3PH	Input 450VDC Output 400VAC 50Hz Input 650VDC Output 400VAC 50Hz Input 850VDC Output 400VAC 50Hz
Grid+battery charging		Input 650VDC Output 400VAC 50Hz
Grid+battery discharging		Input 650VDC Output 400VAC 50Hz
Battery charging		Input AC 400V 50Hz
Grid Mode (Full load)	HYD 10KTL-3PH	Input 250VDC Output 400VAC 50Hz Input 550VDC Output 400VAC 50Hz Input 850VDC Output 400VAC 50Hz
Grid+battery charging		Input 850VDC Output 400VAC 50Hz
Grid+battery discharging		Input 850VDC Output 400VAC 50Hz
Battery charging		Input AC 400V 50Hz



FOR HARMONICS AND FLICKER TEST:

Test Mode	Test Model	Test Standard	Test Voltage
Grid Mode (Full load)	HYD 10KTL-3PH	EN 61000-3-2	Input 850VDC Output 400VAC 50Hz
		EN 61000-3-2	
	HYD 20KTL-3PH	EN 61000-3-11	
		EN 61000-3-12	

IMMUNITY TESTS:

Test Mode	Test Model	Test Voltage
Grid Mode (10% load)	HYD 20KTL-3PH	Input 450VDC Output 400VAC 50Hz
		Input 650VDC Output 400VAC 50Hz
		Input 850VDC Output 400VAC 50Hz
Grid+battery charging		Input 450VDC Output 400VAC 50Hz
Grid+battery discharging		Input 450VDC Output 400VAC 50Hz
Battery charging		Input AC 400V 50Hz



2.3 GENERAL DESCRIPTION OF APPLIED STANDARDS

The EUT has been tested and complied with the requirements of the following standards:

EN 61000-6-3:2007+A1:2011+AC:2012

EN 61000-3-11:2000

EN 61000-3-12:2011

EN IEC 61000-3-2:2019

EN 61000-3-3:2013+A1:2019

EN 61000-6-2:2005

IEC 61000-4-2:2008 ED. 2.0

IEC 61000-4-3:2010 ED. 3.2

IEC 61000-4-4:2012 ED. 3.0

IEC 61000-4-5:2017 ED. 3.1

IEC 61000-4-6:2013 ED. 4.0

IEC 61000-4-8:2009 ED. 2.0

NOTE: The above IEC basic standards are applied with latest version if customer has no special requirement.

2.4 DESCRIPTION OF SUPPORT UNITS

The EUT has been tested as an independent unit together with other necessary accessories or support units. The following support units or accessories were used to form a representative test configuration during the tests.

NO.	PRODUCT	BRAND	MODEL NO.	SERIAL NO.	FCC ID
1	DC Source	Chroma	62150H-1000S	62150EF00488	N/A

NO.	SIGNAL CABLE DESCRIPTION OF THE ABOVE SUPPORT UNITS
1	AC Line: Unshielded, Detachable 2.0m, DC Line: Unshielded, Detachable 2.0m;



3 EMISSION TEST

3.1 CONDUCTED EMISSION MEASUREMENT

3.1.1 LIMITS OF CONDUCTED EMISSION MEASUREMENT

FREQUENCY (MHz)	dBuV	
	Quasi-peak	Average
0.15 - 0.5	66 - 56	56 - 46
0.50 - 5.0	56	46
5.0 - 30.0	60	50

- Note:** (1) The lower limit shall apply at the transition frequencies.
(2) The limit decreases in line with the logarithm of the frequency in the range of 0.15 to 0.50 MHz.

3.1.2 TEST INSTRUMENTS

Equipment	Manufacturer	Model No.	Serial No.	Last Cal.	Next Cal.
EMI Test Receiver	Rohde&Schwarz	ESCS30	100199	Mar. 18,20	Mar. 17,21
Pulse Limiter	Rohde&Schwarz	ESH3-Z2	100168	Sep. 18,19	Sep. 17,20
Artificial Mains Network	Rohde&Schwarz	ESH2-Z5	100071	Mar. 25,20	Mar. 24,21
Artificial Mains Network	SCHWARZBEC K	NNLK 8129	8129-264	Mar. 18,20	Mar. 17,21
Voltage probe	SCHWARZBEC K	TK 9421	TK 9421-176	Sep. 24,19	Sep. 23,20
Test software	ADT	ADT_Cond_ V7.3.7	N/A	N/A	N/A

- NOTE:** 1. The test was performed in shielded room 843.
2. The calibration interval of the above test instruments is 12 months. And the calibrations are traceable to CEPREI/CHINA, GRGT/CHINA and NIM/CHINA.



3.1.3 TEST PROCEDURE

- a. The EUT was placed 0.4 meters from the conducting wall of the shielded room with EUT being connected to the power mains through a line impedance stabilization network (LISN). Other support units were connected to the power mains through another LISN. The two LISNs provide 50 Ohm/ 50uH of coupling impedance for the measuring instrument.
- b. Both lines of the power mains connected to the EUT were checked for maximum conducted interference.
- c. The frequency range from 150 kHz to 30 MHz was searched. Emission levels under (Limit – 20dB) were not recorded.

3.1.4 DEVIATION FROM TEST STANDARD

No deviation



3.1.5 TEST SETUP

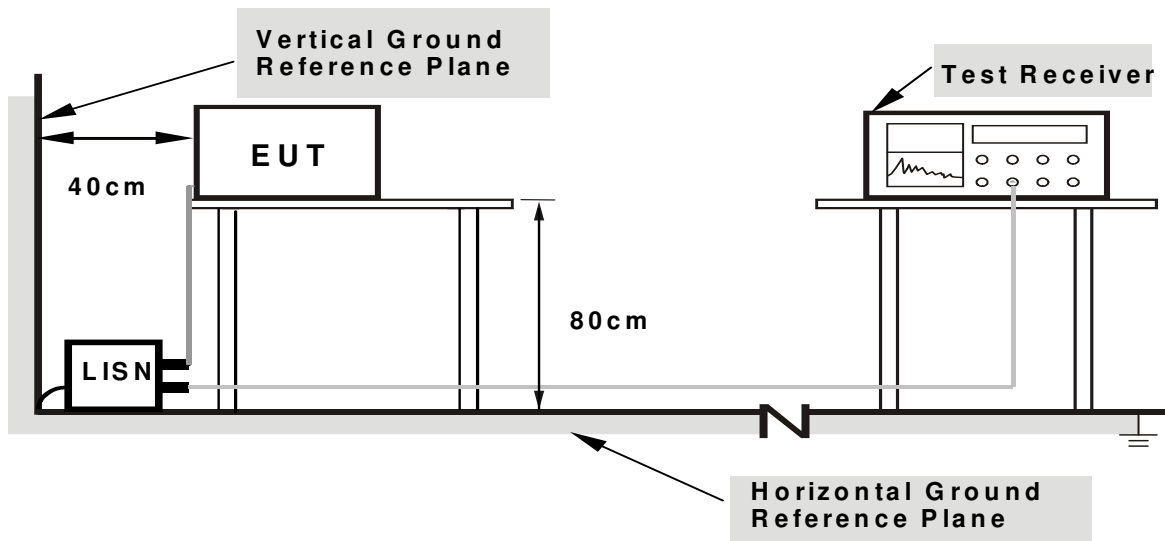

- Note:**
1. Support units were connected to second LISN.
 2. Both of LISNs (AMN) are 80cm from EUT and at least 80cm from other units and other metal planes support units.

3.1.6 EUT OPERATING CONDITIONS

- a. Turned on the power of all equipment.
- b. EUT was operated according to the type description in manufacturer's specifications or the User's Manual.



3.1.7 TEST RESULTS

TEST MODE	See section 2.2	6dB BANDWIDTH	9 kHz
TEST VOLTAGE	See section 2.2	PHASE	Line (L1)
ENVIRONMENTAL CONDITIONS	25deg. C, 46% RH	TESTED BY: Wang	

No	Freq. [MHz]	Corr. Factor (dB)	Reading Value		Emission Level		Limit		Margin	
			[dB (uV)]		[dB (uV)]		[dB (uV)]		(dB)	
			Q.P.	AV.	Q.P.	AV.	Q.P.	AV.	Q.P.	AV.
1	0.16172	9.11	43.82	41.30	52.93	50.41	65.38	55.38	-12.44	-4.96
2	0.22031	9.68	37.66	33.44	47.34	43.12	62.81	52.81	-15.47	-9.69
3	0.23984	9.69	37.60	33.84	47.29	43.53	62.10	52.10	-14.82	-8.58
4	0.88047	9.68	27.96	26.55	37.64	36.23	56.00	46.00	-18.36	-9.77
5	1.01953	9.67	28.91	27.46	38.58	37.13	56.00	46.00	-17.42	-8.87
6	9.55859	9.48	29.03	25.71	38.51	35.19	60.00	50.00	-21.49	-14.81

REMARK: The emission levels of other frequencies were very low against the limit.

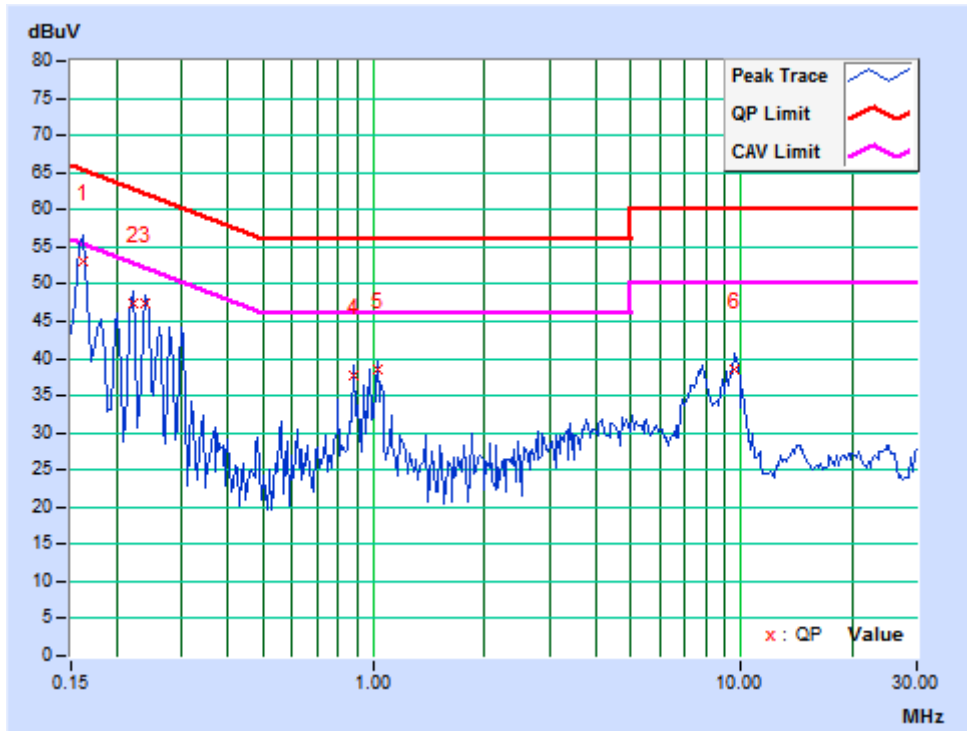



TEST MODE	See section 2.2	6dB BANDWIDTH	9 kHz
TEST VOLTAGE	See section 2.2	PHASE	Line (L2)
ENVIRONMENTAL CONDITIONS	25deg. C, 46% RH		TESTED BY: Wang

No	Freq. [MHz]	Corr. Factor (dB)	Reading Value		Emission Level		Limit		Margin	
			[dB (uV)]		[dB (uV)]		[dB (uV)]		(dB)	
			Q.P.	AV.	Q.P.	AV.	Q.P.	AV.	Q.P.	AV.
1	0.15781	9.05	45.82	44.64	54.87	53.69	65.58	55.58	-10.70	-1.88
2	0.22031	9.68	36.29	32.40	45.97	42.08	62.81	52.81	-16.84	-10.73
3	0.23984	9.69	36.83	35.07	46.52	44.76	62.10	52.10	-15.59	-7.35
4	0.88047	9.68	24.85	23.58	34.53	33.26	56.00	46.00	-21.47	-12.74
5	1.01953	9.67	27.08	25.34	36.75	35.01	56.00	46.00	-19.25	-10.99
6	7.83203	9.52	17.31	12.11	26.83	21.63	60.00	50.00	-33.17	-28.37

REMARK: The emission levels of other frequencies were very low against the limit.

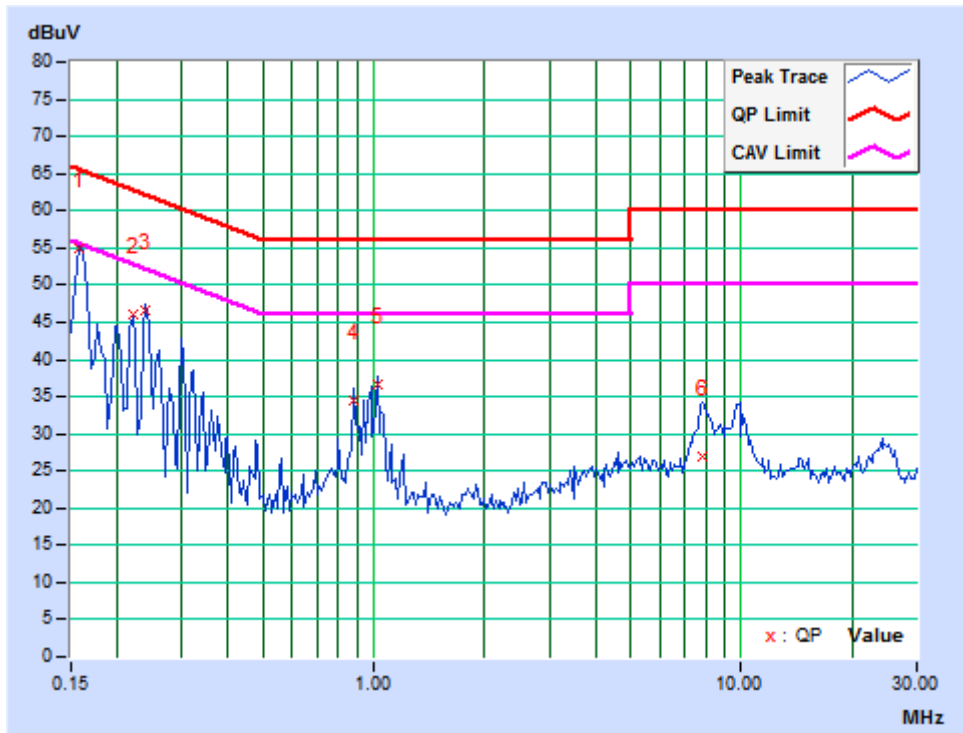



TEST MODE	See section 2.2	6dB BANDWIDTH	9 kHz
TEST VOLTAGE	See section 2.2	PHASE	Line (L3)
ENVIRONMENTAL CONDITIONS	25deg. C, 46% RH		TESTED BY: Wang

No	Freq. [MHz]	Corr. Factor (dB)	Reading Value		Emission Level		Limit		Margin	
			[dB (uV)]		[dB (uV)]		[dB (uV)]		(dB)	
			Q.P.	AV.	Q.P.	AV.	Q.P.	AV.	Q.P.	AV.
1	0.15781	9.05	45.66	43.50	54.71	52.55	65.58	55.58	-10.86	-3.02
2	0.23594	9.68	34.44	31.89	44.12	41.57	62.24	52.24	-18.11	-10.66
3	0.88047	9.68	25.55	24.87	35.23	34.55	56.00	46.00	-20.77	-11.45
4	1.01953	9.67	26.86	24.94	36.53	34.61	56.00	46.00	-19.47	-11.39
5	7.85938	9.52	26.29	20.80	35.81	30.32	60.00	50.00	-24.19	-19.68
6	9.54297	9.48	23.83	19.54	33.31	29.02	60.00	50.00	-26.69	-20.98

REMARK: The emission levels of other frequencies were very low against the limit.

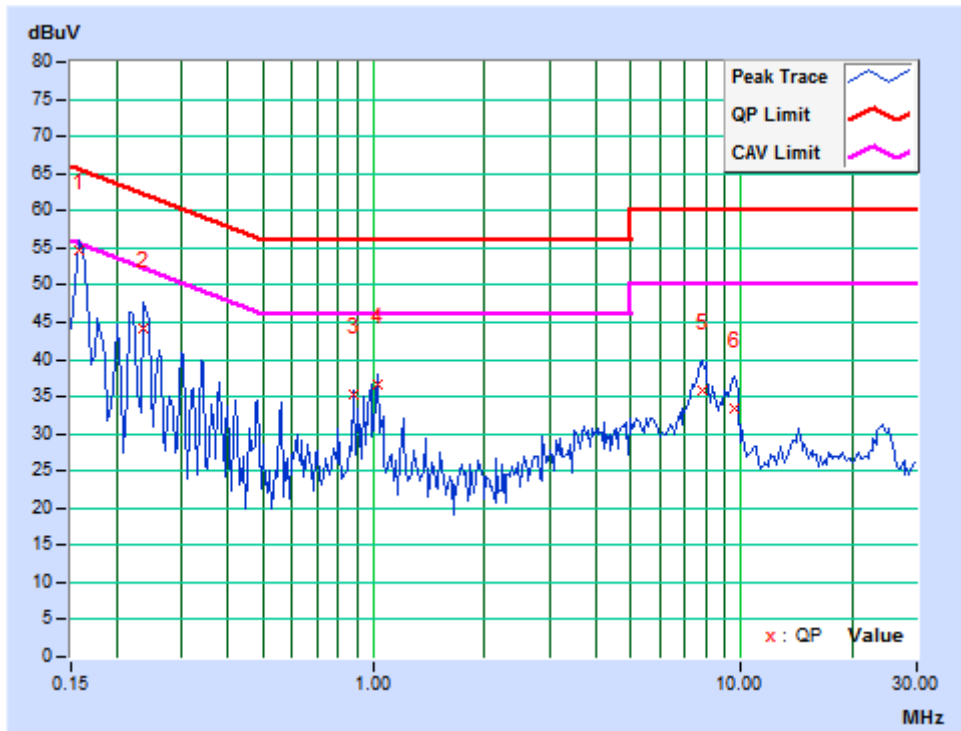



TEST MODE	See section 2.2	6dB BANDWIDTH	9 kHz
TEST VOLTAGE	See section 2.2	PHASE	Neutral (N)
ENVIRONMENTAL CONDITIONS	25deg. C, 46% RH	TESTED BY: Wang	

No	Freq. [MHz]	Corr. Factor (dB)	Reading Value		Emission Level		Limit		Margin	
			[dB (uV)]		[dB (uV)]		[dB (uV)]		(dB)	
			Q.P.	AV.	Q.P.	AV.	Q.P.	AV.	Q.P.	AV.
1	0.16562	9.23	26.50	17.04	35.73	26.27	65.18	55.18	-29.45	-28.91
2	0.19687	9.68	21.01	17.34	30.69	27.02	63.74	53.74	-33.05	-26.72
3	0.27891	9.75	20.51	17.68	30.26	27.43	60.85	50.85	-30.59	-23.42
4	0.60313	9.77	6.60	2.80	16.37	7.97	56.00	46.00	-39.63	-38.03
5	7.96094	9.65	9.09	4.46	18.74	14.11	60.00	50.00	-41.26	-35.89
6	23.64063	9.40	18.44	13.46	27.84	22.86	60.00	50.00	-32.16	-27.14

REMARK: The emission levels of other frequencies were very low against the limit.





3.2 RADIATED EMISSION MEASUREMENT

3.2.1 LIMITS OF RADIATED EMISSION MEASUREMENT

TEST STANDARD: EN 61000-6-3

FOR FREQUENCY BELOW 1000 MHz

FREQUENCY (MHz)	3m	10m
	Quasi-Peak(dBuV/m)	Quasi-Peak (dBuV/m)
30 – 230	40	30
230 – 1000	47	37

FREQUENCY RANGE OF RADIATED MEASUREMENT (For unintentional radiators)

Highest frequency generated or Upper frequency of measurement used in the device or on which the device operates or tunes (MHz)	Range (MHz)
Below 108	1000
108 – 500	2000
500 – 1000	5000
Above 1000	Up to 5 times of the highest frequency or 6 GHz, whichever is less

FOR FREQUENCY ABOVE 1000 MHz

FREQUENCY (GHz)	3m	
	PEAK(dBuV/m)	AVERAGE(dBuV/m)
1 to 3	70	50
3 to 6	74	54

NOTE: (1) The lower limit shall apply at the transition frequencies.
(2) Emission level (dBuV/m) = 20 log Emission level (uV/m).



3.2.2 TEST INSTRUMENTS

FOR FREQUENCY BELOW 1GHz

Equipment	Manufacturer	Model No.	Serial No.	Last Cal.	Next Cal.
EMI Test Receiver	Rohde&Schwarz	ESU26	100005	May 14, 20	May 13, 21
EMI Test Receiver	Rohde&Schwarz	ESR7	101564	Mar. 18,20	Mar. 17,21
Trilog-Broadband Antenna	SCHWARZBECK	VULB 9168	9168-555	Nov. 24, 19	Nov. 23, 20
Trilog-Broadband Antenna	SCHWARZBECK	VULB 9168	9168-554	Dec. 01, 19	Nov. 30, 20
Preamplifier	EMCI	EMC1135	980378	Mar. 15,20	Mar. 14,21
Preamplifier	EMCI	EMC1135	980423	Mar. 15,20	Mar. 14,21
10m Semi-anechoic Chamber	CHANGLING	21.4m*12.1m*8.8m	NSEMC006	Oct. 19,19	Oct. 18,20
Test Software	ADT	ADT_Radiated_V8.7.07	N/A	N/A	N/A

- NOTE:** 1. The test was performed in 10m Chamber.
 2. The calibration interval of the above test instruments is 12 months. And the calibrations are traceable to CEPREI/CHINA, GRGT/CHINA and NIM/CHINA

FOR FREQUENCY ABOVE 1GHz

Equipment	Manufacturer	Model No.	Serial No.	Last Cal.	Next Cal.
Horn Antenna	ETS-Lindgren	3117	00085519	Nov. 24, 19	Nov. 23, 20
Horn Antenna	SCHWARZBECK	BBHA 9170	BBHA9170147	May 10,20	May 09,21
Signal and Spectrum Analyzer	Rohde&Schwarz	FSV40	101003	Mar. 18,20	Mar. 17,21
Broadband Preamplifier (1~18GHz)	SCHWARZBECK	BBV9718	266	May 09,20	May 08,21
Pre-Amplifier (18GHz-40GHz)	EMCI	EMC 184045	980102	Mar. 04,20	Mar. 03,21
Test Software	ADT	ADT_Radiated_V8.7.07	N/A	N/A	N/A

- NOTE:** 1. The test was performed in 10m Chamber.
 2. The calibration interval of the above test instruments is 12 months. And the calibrations are traceable to CEPREI/CHINA, GRGT/CHINA and NIM/CHINA.



3.2.3 TEST PROCEDURE

<Frequency Range below 1GHz>

- a. The EUT was placed on the top of a rotating table 0.8 meters above the ground at a 10 meter chamber room. The table was rotated 360 degrees to determine the position of the highest radiation.
- b. The EUT was set 10 meters away from the interference-receiving antenna, which was mounted on the top of a variable-height antenna tower.
- c. The height of antenna is varied from one meter to four meters above the ground to determine the maximum value of the field strength. Both horizontal and vertical polarizations of the antenna are set to make the measurement.
- d. For each suspected emission, the EUT was arranged to its worst case and then the antenna was tuned to heights from 1 meter to 4 meters and the turn table was turned from 0 degrees to 360 degrees to find the maximum reading.
- e. The test-receiver system was set to quasi-peak detect function and specified bandwidth with maximum hold mode when the test frequency is below 1 GHz.

NOTE:

1. The resolution bandwidth of test receiver/spectrum analyzer is 120kHz for Quasi-peak detection (QP) at frequency below 1GHz.
2. Emission level(dBuV/m)=Raw Value(dBuV) + Correction Factor(dB/m)
3. Correction Factor(dB/m) = Antenna Factor (dB/m) + Cable Factor (dB) (if the raw value not contains the amplifier);
4. Correction Factor(dB/m) = Antenna Factor (dB/m) + Cable Factor (dB) – Amplifier Gain(dB) (if the raw value contains the amplifier).
5. Margin value = Emission level – Limit value.



<Frequency Range above 1GHz>

- a. The EUT was placed on the top of a rotating table 0.8 meters above the ground at a 10 meter Semi-anechoic chamber room. The table was rotated 360 degrees to determine the position of the highest radiation.
- b. The EUT was set 3 meters away from the interference-receiving antenna, which was mounted on the top of a variable-height antenna tower.
- c. The height of antenna can be varied from one meter-to four meters, the height of adjustment depends on the EUT height and the antenna 3dB beamwidth both, to detect the maximum value of the field strength. Both horizontal and vertical polarizations of the antenna are set to make the measurement. The bore sight should be used during the test above 1GHz.
- d. For each suspected emission, the EUT was arranged to its worst case and then the antenna was tuned to heights and the rotatable table was turned from 0 degrees to 360 degrees to find the maximum reading.
- e. The test receiver/spectrum was set to peak and average detect function and specified bandwidth with maximum hold mode when the test frequency is above 1 GHz.

NOTE:

1. The resolution bandwidth is 1MHz and video bandwidth of test receiver/spectrum analyzer is 3MHz for Peak detection at frequency above 1GHz. The resolution bandwidth of test receiver/spectrum analyzer is 1 MHz for Average detection (AV) at frequency above 1GHz.
2. For measurement of frequency above 1000 MHz, the EUT was set 3 meters away from the receiver antenna.
3. $\text{Emission level(dBuV/m)} = \text{Raw Value(dBuV)} + \text{Correction Factor(dB/m)}$
4. $\text{Correction Factor(dB/m)} = \text{Antenna Factor (dB/m)} + \text{Cable Factor (dB)}$ (if the raw value not contains the amplifier);
5. $\text{Correction Factor(dB/m)} = \text{Antenna Factor (dB/m)} + \text{Cable Factor (dB)} - \text{Amplifier Gain(dB)}$ (if the raw value contains the amplifier).
6. $\text{Margin value} = \text{Emission level} - \text{Limit value}$.

3.2.4 DEVIATION FROM TEST STANDARD

No deviation

3.2.5 TEST SETUP

<Frequency Range below 1GHz>

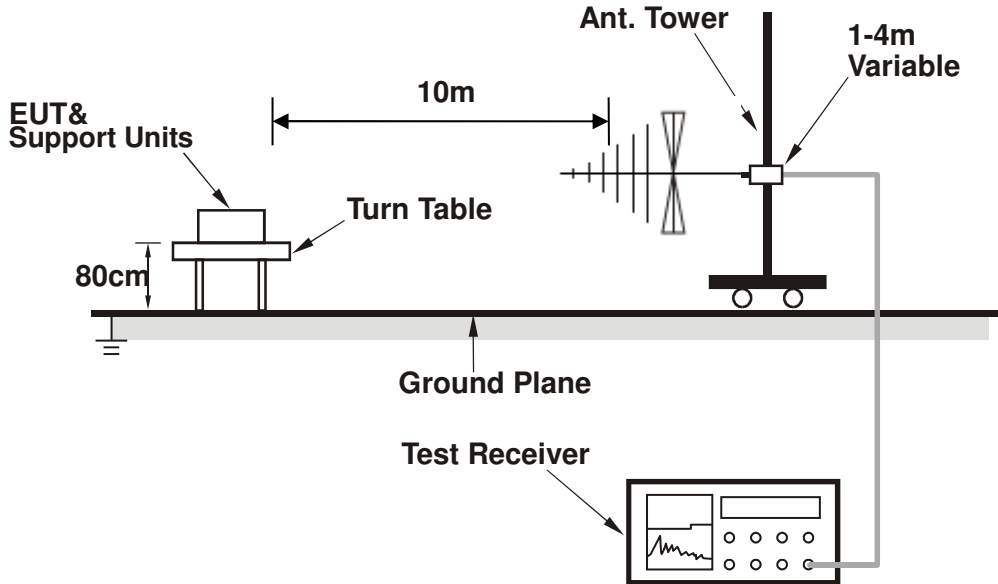

<Frequency Range above 1GHz>

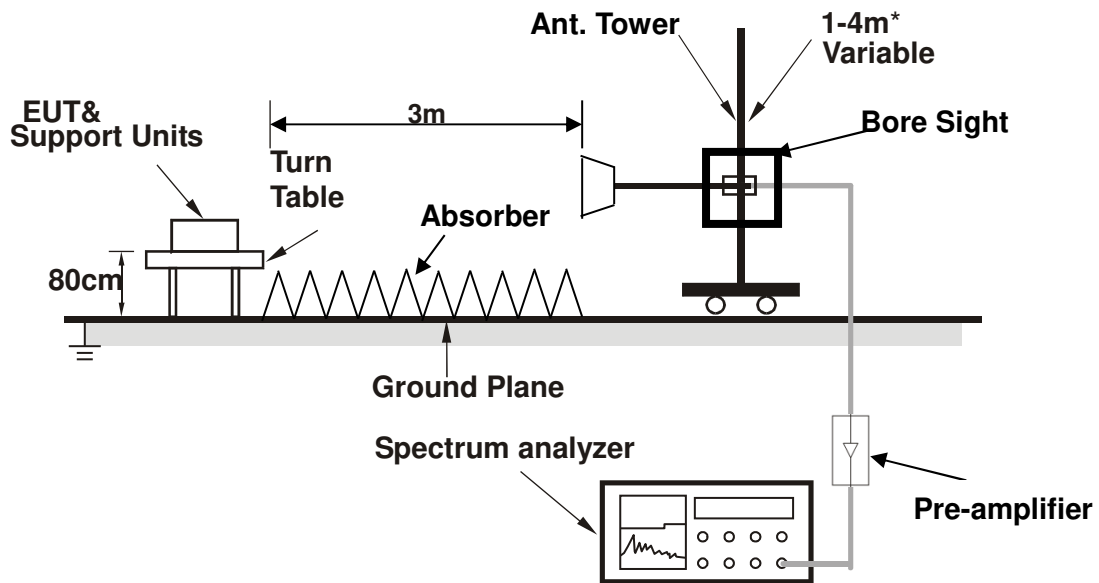

* :depends on the EUT height and the antenna 3dB beamwidth both, refer to section 7.3 of CISPR 16-2-3.

3.2.6 EUT OPERATING CONDITIONS

Same as item 3.1.6



3.2.7 TEST RESULTS

TEST MODE	See section 2.2	FREQUENCY RANGE	30-1000 MHz
TEST VOLTAGE	See section 2.2	DETECTOR FUNCTION & BANDWIDTH	Quasi-Peak, 120kHz
ENVIRONMENTAL CONDITIONS	17 deg. C, 64% RH	TESTED BY: Cheng Zhong	

ANTENNA POLARITY & TEST DISTANCE: HORIZONTAL AT 10 M								
No.	Freq. (MHz)	Correction Factor (dB/m)	Raw Value (dBuV)	Emission Level (dBuV/m)	Limit (dBuV/m)	Margin (dB)	Antenna Height (cm)	Table Angle (Degree)
1	119.4825	-21.85	41.07	19.22	30.00	-10.78	400	157
2	147.2100	-16.20	39.60	23.40	30.00	-6.60	400	235
3	178.5312	-17.90	36.42	18.52	30.00	-11.48	400	43
4	195.9913	-18.94	39.15	20.21	30.00	-9.79	400	43
5	214.6637	-18.36	36.43	18.07	30.00	-11.93	400	357
6	974.1738	-0.95	30.50	29.55	37.00	-7.45	200	190

- REMARK:**
1. Peak detector quick scan is showed on the graph and final quasi-peak detector data is measured corresponding to relevant limit and recorded in the data table.
 2. Negative sign (-) in the margin column signify levels below the limit.
 3. Frequency range scanned: 30MHz to 1000MHz.
 4. Only emissions significantly above equipment noise floor are reported

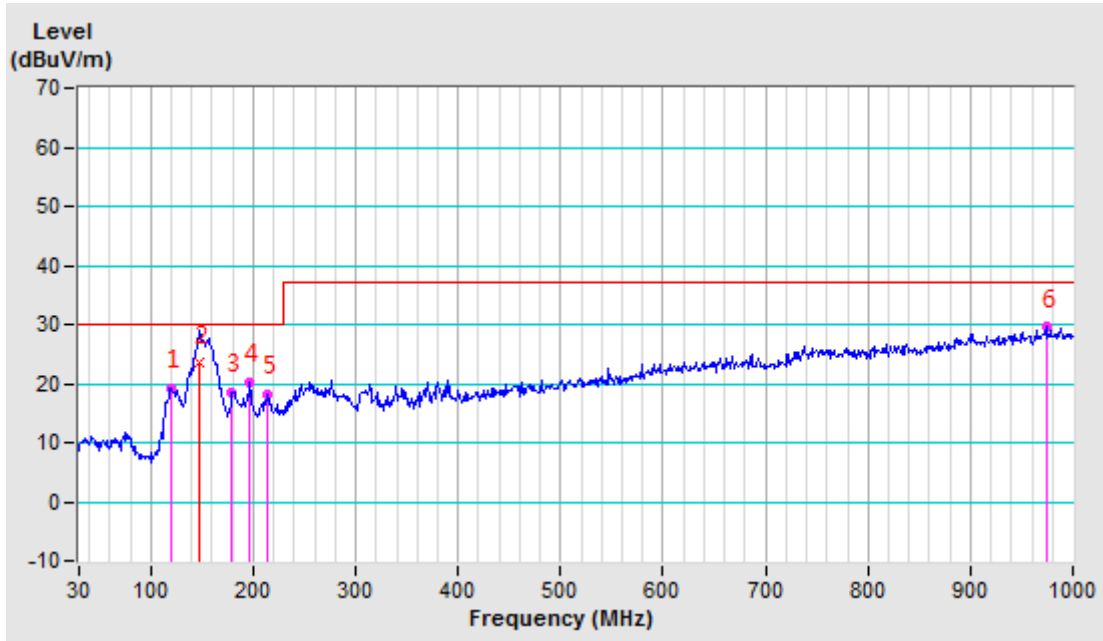



TEST MODE	See section 2.2	FREQUENCY RANGE	30-1000 MHz
TEST VOLTAGE	See section 2.2	DETECTOR FUNCTION & BANDWIDTH	Quasi-Peak, 120kHz
ENVIRONMENTAL CONDITIONS	17 deg. C, 64% RH	TESTED BY: Cheng Zhong	

ANTENNA POLARITY & TEST DISTANCE: VERTICAL AT10 M								
No.	Freq. (MHz)	Correction Factor (dB/m)	Raw Value (dBuV)	Emission Level (dBuV/m)	Limit (dBuV/m)	Margin (dB)	Antenna Height (cm)	Table Angle (Degree)
1	72.7306	-20.57	43.62	23.05	30.00	-6.95	300	320
2	79.4240	-21.34	44.67	23.33	30.00	-6.67	100	309
3	122.0576	-18.42	41.64	23.22	30.00	-6.78	300	339
4	145.6298	-16.23	43.20	26.97	30.00	-3.03	100	358
5	179.7755	-18.14	41.88	23.74	30.00	-6.26	100	356
6	217.1709	-18.37	38.79	20.42	30.00	-9.58	100	308

- REMARK:**
1. Peak detector quick scan is showed on the graph and final quasi-peak detector data is measured corresponding to relevant limit and recorded in the data table.
 2. Negative sign (-) in the margin column signify levels below the limit.
 3. Frequency range scanned: 30MHz to 1000MHz.
 4. Only emissions significantly above equipment noise floor are reported

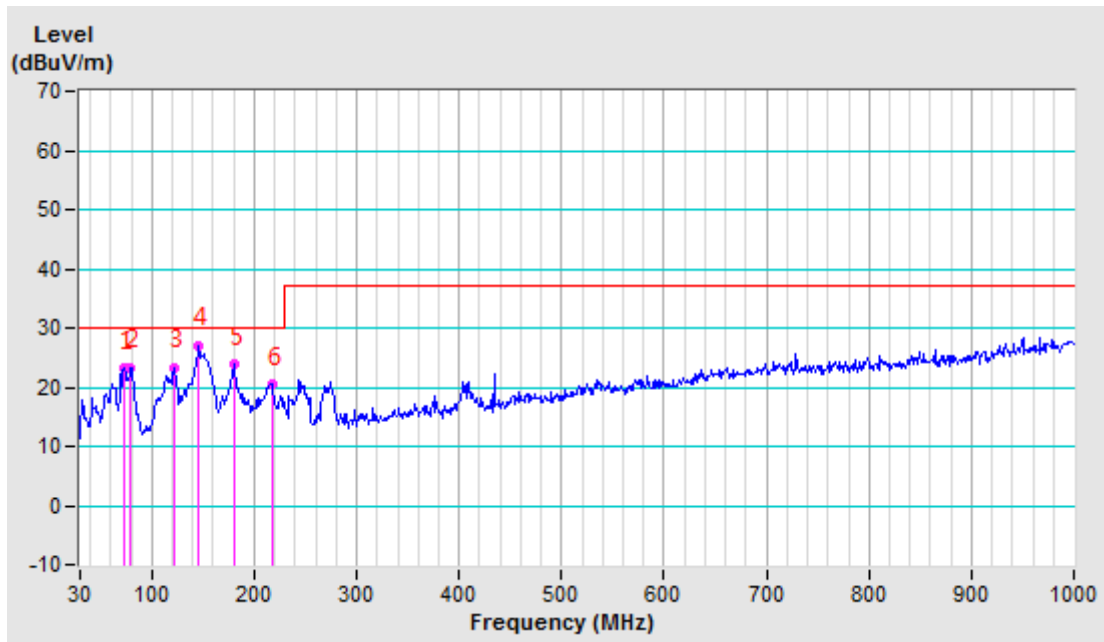



3.3 HARMONICS CURRENT MEASUREMENT

3.3.1 LIMITS OF HARMONICS CURRENT MEASUREMENT

TEST STANDARD: EN 61000-3-2 and EN 61000-3-12

DESCRIPTION & MANUFACTURER	MANUFACTURER	MODEL NO.	SERIAL NO.	CALIBRATED DATE	CALIBRATED UNTIL
PRECISION POWER ANALYZER	YOKOGAWA	WT3000	91M210852	Sep. 11,19	Sep. 11,20
Test Software	YOKOGAWA	IEC61000	N/A	N/A	N/A
REFERENCE IMPEDANCE NETWORK	Voltech	EUR	3018	Sep. 11,19	Sep. 11,20

- NOTE:** 1. The test was performed in PV Room.
 2. The calibration interval of the above test instruments is 12 months and the calibrations are traceable to CEPREI/CHINA and NIM/CHINA.

3.3.2 CURRENT EMISSION LIMITS FOR EQUIPMENT OTHER THAN BALANCED THREE-PHASE EQUIPMENT

Minimal R_{sce}	Admissible individual harmonic current I_n/I_1 ^a						Admissible harmonic current distortion factors	
	%						%	
	I_3	I_5	I_7	I_9	I_{11}	I_{13}	<i>THD</i>	<i>PWHD</i>
33	21,6	10,7	7,2	3,8	3,1	2	23	23
66	24	13	8	5	4	3	26	26
120	27	15	10	6	5	4	30	30
250	35	20	13	9	8	6	40	40
≥ 350	41	24	15	12	10	8	47	47

The relative values of even harmonics up to order 12 shall not exceed $16/n$ %. Even harmonics above order 12 are taken into account in *THD* and *PWHD* in the same way as odd order harmonics.

NOTE Linear interpolation between successive R_{sce} values is permitted. See also Annex B.

^a I_1 = reference fundamental current; I_n = harmonic current component.



3.3.3 CURRENT EMISSION LIMITS FOR BALANCED THREE-PHASE EQUIPMENT

Minimal $R_{s_{ce}}$	Admissible individual harmonic current I_n/I_1^a %				Admissible harmonic current distortion factors %	
	I_5	I_7	I_{11}	I_{13}	<i>THD</i>	<i>PWHD</i>
33	10,7	7,2	3,1	2	13	22
66	14	9	5	3	16	25
120	19	12	7	4	22	28
250	31	20	12	7	37	38
≥350	40	25	15	10	48	46

The relative values of even harmonics up to order 12 shall not exceed $16/n$ %. Even harmonics above order 12 are taken into account in *THD* and *PWHD* in the same way as odd order harmonics.

NOTE Linear interpolation between successive $R_{s_{ce}}$ values is permitted. See also Annex B.

^a I_1 = reference fundamental current; I_n = harmonic current component.

3.3.4 CURRENT EMISSION LIMITS FOR BALANCED THREE-PHASE EQUIPMENT UNDER SPECIFIED CONDITIONS

Minimal $R_{s_{ce}}$	Admissible individual harmonic current I_n/I_1^a %				Admissible harmonic current distortion factors %	
	I_5	I_7	I_{11}	I_{13}	<i>THD</i>	<i>PWHD</i>
33	10,7	7,2	3,1	2	13	22
≥120	40	25	15	10	48	46

The relative values of even harmonics up to order 12 shall not exceed $16/n$ %. Even harmonics above order 12 are taken into account in *THD* and *PWHD* in the same way as odd order harmonics.

NOTE Linear interpolation between successive $R_{s_{ce}}$ values is permitted. See also Annex B.

^a I_1 = reference fundamental current; I_n = harmonic current component.



3.3.5 DEVIATION FROM TEST STANDARD

No deviation

3.3.6 TEST SETUP

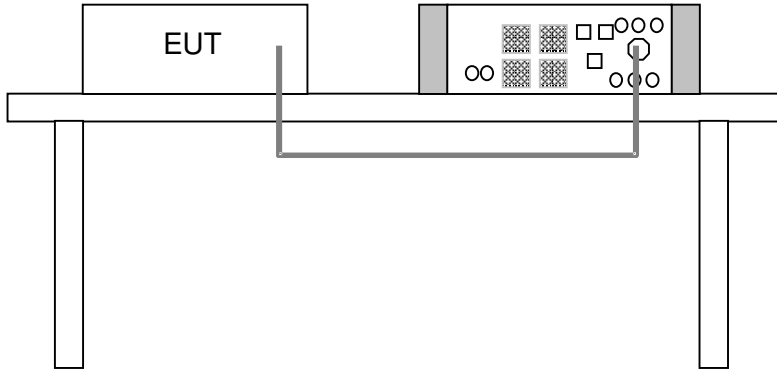

3.3.7 EUT OPERATING CONDITIONS

Same as item 3.1.6



3.3.8 TEST RESULTS

Model: HYD 20KTL-3PH

Regulation : IEC61000-3-12
 IEC61000-4-7 Ed2.0 A1
 MeasureTime : 150sec
 Model : YOKOGAWA WT3000
 Wiring : 3P4W(3P:three-phase)
 Element : 1
 Range : 300V/100.0A
 Rating Voltage : 400 V
 Ieq : 15.0000 A
 Z Impedance : 0.1200 ohm
 I1 : 27.5647 A
 Power Rsce : 118.996
 Max Rsce : 33.000

PASS

Ssc : 342946.06
 Min Rsce : 33.0000
 Apply Limit : equipment other than balanced 3-phase.
 Situation1 : 0.98% (Pass)
 Term a : 238.76 - 284.04deq (Fail)
 Term c(15) : 0.67% (Pass)
 Term c(17) : 0.46% (Pass)

[Average]
 Voltage(rms) : 230.76 V
 Current(rms) : 27.57 A
 Frequency : 50.00 Hz
 Power Factor : 1.00
 Sigma W : 19188.98 W
 THC : 0.50 A
 V THD : 0.06 %
 A THD : 1.81 %
 P THD : 0.00 %

[Maximum]
 Voltage(rms) : 230.77 V
 Current(rms) : 27.72 A
 Frequency : 50.01 Hz
 Power Factor : 1.00
 Sigma W : 19299.82 W
 THC : 0.53 A
 V THD : 0.06 %
 A THD : 2.00 %
 P THD : 0.00 %

Order	Measure[%]	Limit[%]	Margin[%]
2	0.3125	8.0000	96.1
3	0.8615	21.9800	96.1
4	0.1712	4.0000	95.7
5	0.5976	11.3200	94.7
6	0.1691	2.6667	93.7
7	0.4095	7.3250	94.4
8	0.1384	2.0000	93.1
9	0.2789	3.8250	92.7
10	0.0798	1.6000	95.0
11	0.1150	3.1600	96.4
12	0.9518	1.3333	28.6
13	0.1287	2.0600	93.8
THD	1.8089	23.4750	92.3
PWHD	3.4043	23.4750	85.5

Order	Measure[%]	Limit[%]	Margin[%]
2	0.3688	12.0000	96.9
3	0.9791	32.9700	97.0
4	0.2714	6.0000	95.5
5	0.6693	16.9800	96.1
6	0.2208	4.0000	94.5
7	0.4616	10.9875	95.8
8	0.1637	3.0000	94.5
9	0.3063	5.7375	94.7
10	0.0992	2.4000	95.9
11	0.1426	4.7400	97.0
12	0.9936	2.0000	50.3
13	0.1544	3.0900	95.0
THD	1.9756	35.2125	94.4
PWHD	3.6000	35.2125	89.8

Limit (Yellow), Limit Over (Red), OK (Blue), N/A (White), N/A (rule) (Cyan)

Limit (Yellow), Limit Over (Red), OK (Blue), N/A (White), N/A (rule) (Cyan)

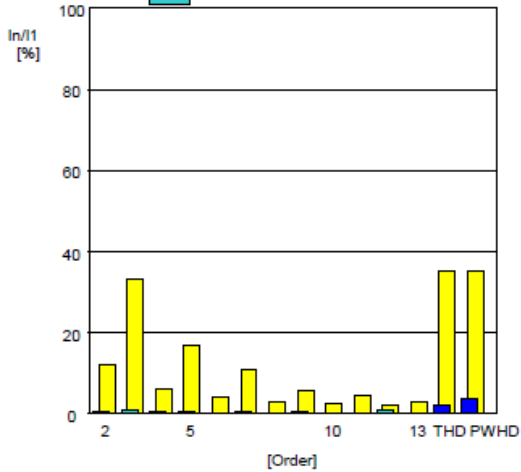
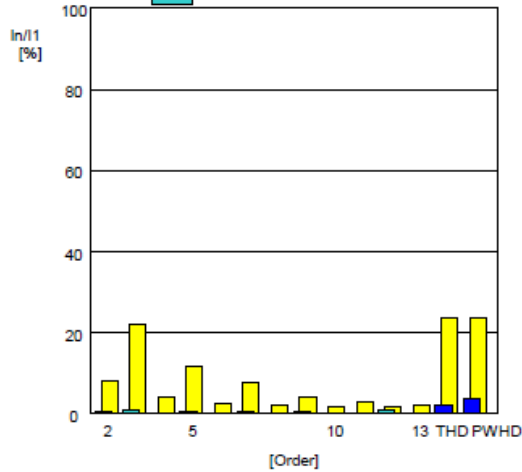



Regulation : IEC61000-3-12
 IEC61000-4-7 Ed2.0 A1
 MeasureTime : 150sec
 Model : YOKOGAWA WT3000
 Wiring : 3P4W(3P:three-phase)
 Element : 2
 Range : 300V/100.0A
 Rating Voltage : 400 V
 I_{eq} : 15.0000 A
 Z Impedance : 0.1200 ohm
 I₁ : 27.7313 A
 Power R_{sce} : 118.996
 Max R_{sce} : 33.000

PASS

Ssc : 342946.06
 Min R_{sce} : 33.0000

Apply Limit : equipment other than balanced 3-phase.
 Situation1 : 0.55% (Pass)
 Term a : 296.34 - 323.20deq (Fail)
 Term c(I5) : 0.87% (Pass)
 Term c(I7) : 0.35% (Pass)

[Average]
 Voltage(rms) : 230.81 V
 Current(rms) : 27.74 A
 Frequency : 50.00 Hz
 Power Factor : 1.00
 Sigma W : 19188.98 W
 THC : 0.48 A
 V THD : 0.05 %
 A THD : 1.75 %
 P THD : 0.00 %

[Maximum]
 Voltage(rms) : 230.81 V
 Current(rms) : 27.90 A
 Frequency : 50.01 Hz
 Power Factor : 1.00
 Sigma W : 19299.82 W
 THC : 0.51 A
 V THD : 0.06 %
 A THD : 1.89 %
 P THD : 0.00 %

Order	Measure[%]	Limit[%]	Margin[%]
2	0.3674	8.0000	95.4
3	0.4669	21.9800	97.9
4	0.1994	4.0000	95.0
5	0.7849	11.3200	93.1
6	0.2182	2.6667	91.8
7	0.2754	7.3250	96.2
8	0.1304	2.0000	93.5
9	0.1321	3.8250	96.5
10	0.0766	1.6000	95.2
11	0.1285	3.1600	95.9
12	0.9797	1.3333	26.5
13	0.1896	2.0600	90.8
THD	1.7394	23.4750	92.6
PWHD	3.4745	23.4750	85.2

Order	Measure[%]	Limit[%]	Margin[%]
2	0.4221	12.0000	96.5
3	0.5489	32.9700	98.3
4	0.3079	6.0000	94.9
5	0.8709	16.9800	94.9
6	0.2768	4.0000	93.1
7	0.3512	10.9875	96.8
8	0.1785	3.0000	94.0
9	0.1857	5.7375	96.8
10	0.1074	2.4000	95.5
11	0.1665	4.7400	96.5
12	1.0130	2.0000	49.4
13	0.2305	3.0900	92.5
THD	1.8982	23.4750	94.6
PWHD	3.6565	35.2125	89.6

Limit (Yellow)
 OK (Blue)
 N/A (rule) (Cyan)
 Limit Over (Red)
 N/A (White)

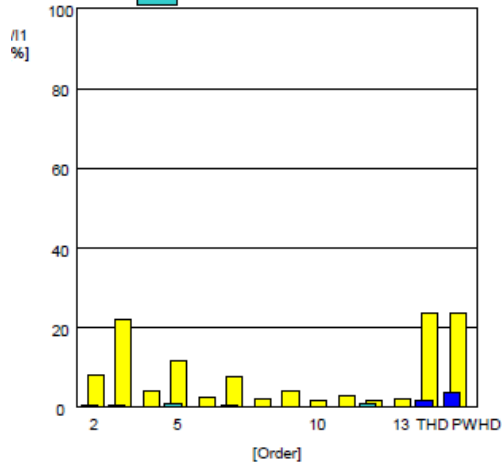

Limit (Yellow)
 OK (Blue)
 N/A (rule) (Cyan)
 Limit Over (Red)
 N/A (White)

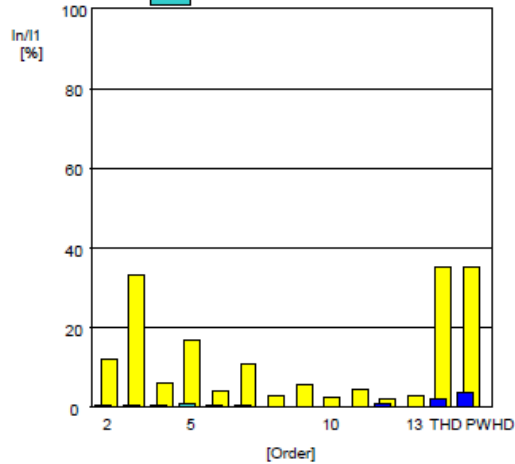



Regulation : IEC61000-3-12
 IEC61000-4-7 Ed2.0 A1
 MeasureTime : 150sec
 Model : YOKOGAWA WT3000
 Wiring : 3P4W(3P:three-phase)
 Element : 3
 Range : 300V/100.0A
 Rating Voltage : 400 V
 I_{eq} : 15.0000 A
 Z Impedance : 0.1200 ohm
 I₁ : 27.8462 A
 Power R_{sce} : 118.996
 Max R_{sce} : 33.000

PASS

Ssc : 342946.06
 Min R_{sce} : 33.0000
 Apply Limit : equipment other than balanced 3-phase.
 Situation1 : 0.65% (Pass)
 Term a : 0.01 - 359.90deq (Fail)
 Term c(I5) : 0.34% (Pass)
 Term c(I7) : 0.56% (Pass)

[Average]
 Voltage(rms) : 230.83 V
 Current(rms) : 27.85 A
 Frequency : 50.00 Hz
 Power Factor : 1.00
 Sigma W : 19188.98 W
 THC : 0.44 A
 V THD : 0.06 %
 A THD : 1.60 %
 P THD : 0.00 %

[Maximum]
 Voltage(rms) : 230.84 V
 Current(rms) : 28.02 A
 Frequency : 50.01 Hz
 Power Factor : 1.00
 Sigma W : 19299.82 W
 THC : 0.47 A
 V THD : 0.06 %
 A THD : 1.75 %
 P THD : 0.00 %

Order	Measure[%]	Limit[%]	Margin[%]
2	0.3088	8.0000	96.1
3	0.5157	21.9800	97.7
4	0.1925	4.0000	95.2
5	0.2838	11.3200	97.5
6	0.1353	2.6667	94.9
7	0.5073	7.3250	93.1
8	0.1173	2.0000	94.1
9	0.1844	3.8250	95.2
10	0.0822	1.6000	94.9
11	0.1528	3.1600	95.2
12	0.9533	1.3333	28.5
13	0.1795	2.0600	91.3
THD	1.5946	23.4750	93.2
PWHD	3.3150	23.4750	85.9

Order	Measure[%]	Limit[%]	Margin[%]
2	0.3652	12.0000	97.0
3	0.6536	32.9700	98.0
4	0.2901	6.0000	95.2
5	0.3364	16.9800	98.0
6	0.1867	4.0000	95.3
7	0.5576	10.9875	94.9
8	0.1372	3.0000	95.4
9	0.2186	5.7375	96.2
10	0.1055	2.4000	95.6
11	0.1879	4.7400	96.0
12	0.9898	2.0000	50.5
13	0.2202	3.0900	92.9
THD	1.7517	23.4750	95.0
PWHD	3.5047	35.2125	90.0

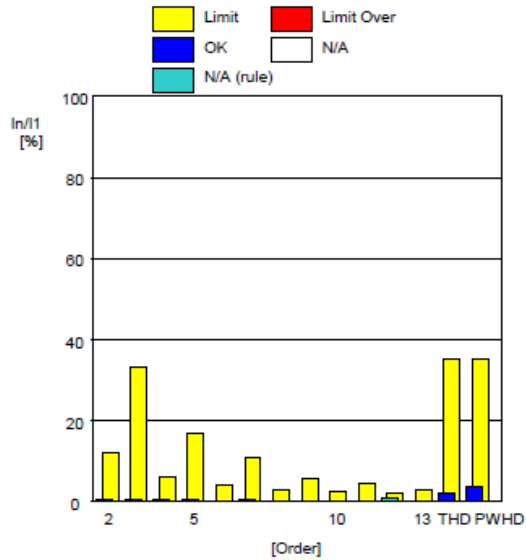
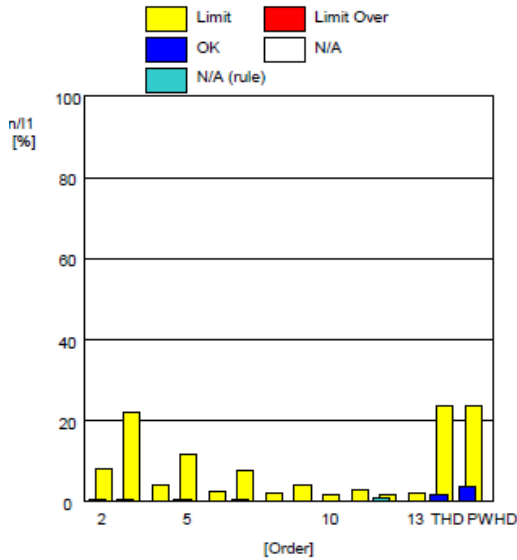



BUREAU VERITAS

Test Report No.: CE200409N067

Model: HYD 10KTL-3PH

***** appliances (Average)

Print Date : Tue May 19 13:44:03 2020
MeasureDate : Tue May 19 13:43:02 2020
Comment : Experimental model Pattern A

Regulation : IEC61000-3-2 Ed3.0 am2
CLASS A
CLASS A
150.00sec
YOKOGAWA WT3000
230.00 V
3P4W
1(U)
300V/100.0A
14.2537 A
230.38 V
50.000 Hz
0.9996
0.2514 A
0.0700 A
0.3972 A

PASS

Set Fundamental I :
Set Power Factor :
Set P :
Sigma W Max : 10008.98 W
Sigma PF : 0.9997
Distortion factor(V) : 0.07 %
V THDS : 0.07 %
V THDG : 0.07 %
Distortion factor(A) : 2.78 %
A THDS : 2.78 %
A THDG : 2.79 %
P THD : 0.00 %
Power Limit : 75 W

Table with 8 columns: Order, Measure[A], Limit[A], Margin[%], Order, Measure[A], Limit[A], Margin[%]. It lists 39 harmonic orders with their respective measured values, limits, and margins.

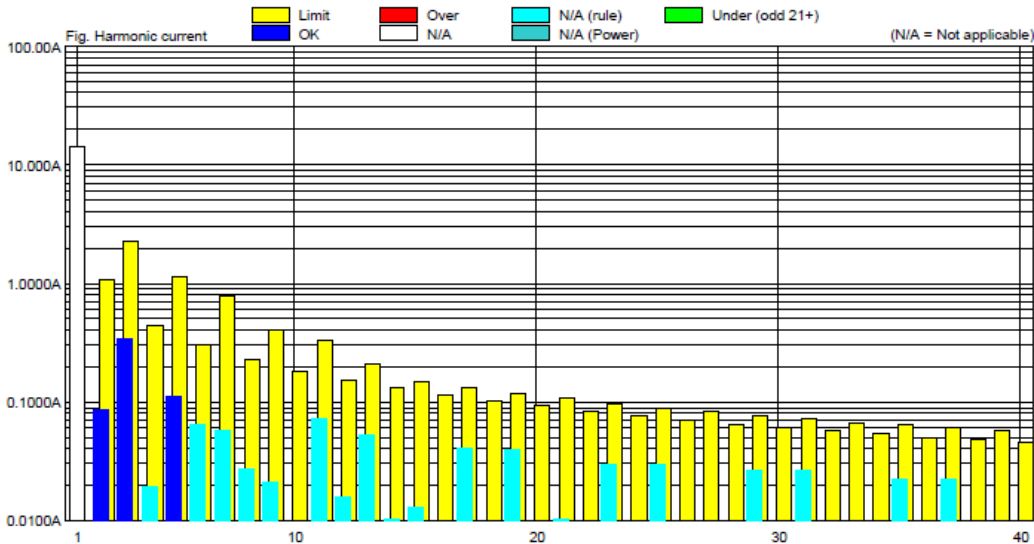



***** appliances (Maximum)

Print Date : Tue May 19 13:44:04 2020
MeasureDate : Tue May 19 13:43:02 2020
Comment : Experimental model Pattern A

Regulation : IEC61000-3-2 Ed3.0 am2
Class : CLASS A
MeasureTime : 150.00sec
Model : YOKOGAWA WT3000
Rating Voltage : 230.00 V
Wiring : 3P4W
Element : 1(U)
Range : 300V/100.0A
Current(rms) : 14.2802 A
Voltage(rms) : 230.42 V
Frequency : 50.006 Hz
Power Factor : 0.9997
Beyond Limit Time : 15.0000 s
Beyond Total Time : 0.0000 s
THC : 0.4157 A

PASS

Set Fundamental I : -----
Set Power Factor : -----
Set P : -----
Sigma W Max : 10008.98 W
Sigma PF : 0.9997
Distortion factor(V) : 0.07 %
V THDS : 0.07 %
V THDG : 0.07 %
Distortion factor(A) : 3.05 %
A THDS : 3.05 %
A THDG : 3.05 %
P THD : 0.00 %
Power Limit : 75 W

Table with 7 columns: Order, Measure[A], Limit[A], Margin[%], Order, Measure[A], Limit[A], Margin[%]. It lists harmonic orders from 1 to 40 with their respective measured values, limits, and margins.

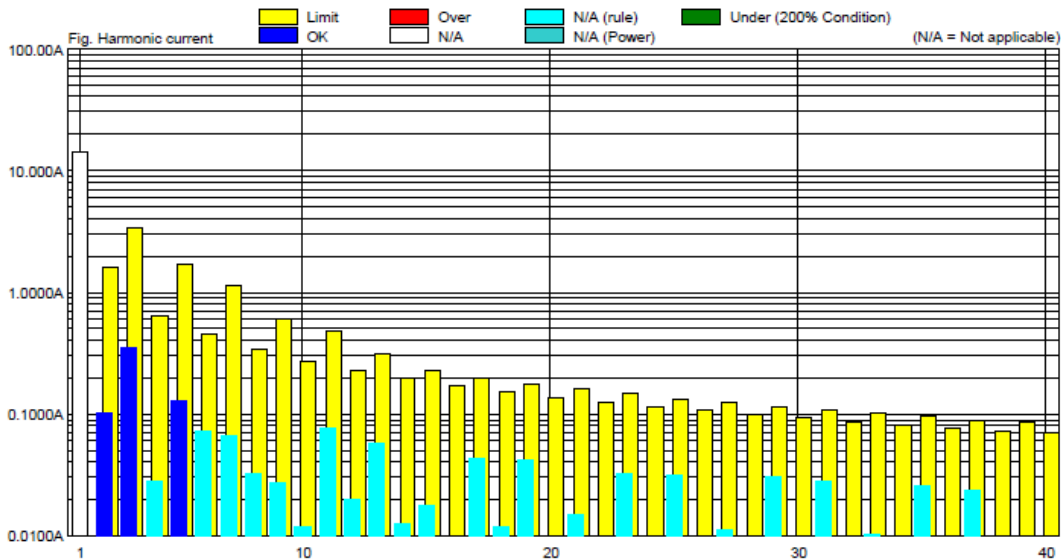



***** appliances (Average)

Print Date : Tue May 19 13:44:04 2020
MeasureDate : Tue May 19 13:43:02 2020
Comment : Experimental model Pattern A

Regulation : IEC61000-3-2 Ed3.0 am2
Class : CLASS A
MeasureTime : 150.00sec
Model : YOKOGAWA WT3000
Rating Voltage : 230.00 V
Wiring : 3P4W
Element : 2(V)
Range : 300V/100.0A
Current(rms) : 14.5354 A
Voltage(rms) : 230.40 V
Frequency : 50.000 Hz
Power Factor : 0.9996
POHC Limit : 0.2514 A
POHC Max : 0.0685 A
THC : 0.3237 A

PASS

Set Fundamental I : -----
Set Power Factor : -----
Set P : -----
Sigma W Max : 10008.98 W
Sigma PF : 0.9997
Distortion factor(V) : 0.06 %
V THDS : 0.06 %
V THDG : 0.06 %
Distortion factor(A) : 2.22 %
A THDS : 2.22 %
A THDG : 2.23 %
P THD : 0.00 %
Power Limit : 75 W

Table with 8 columns: Order, Measure[A], Limit[A], Margin[%], Order, Measure[A], Limit[A], Margin[%]. It lists 40 harmonic orders with their respective measurements, limits, and margins.

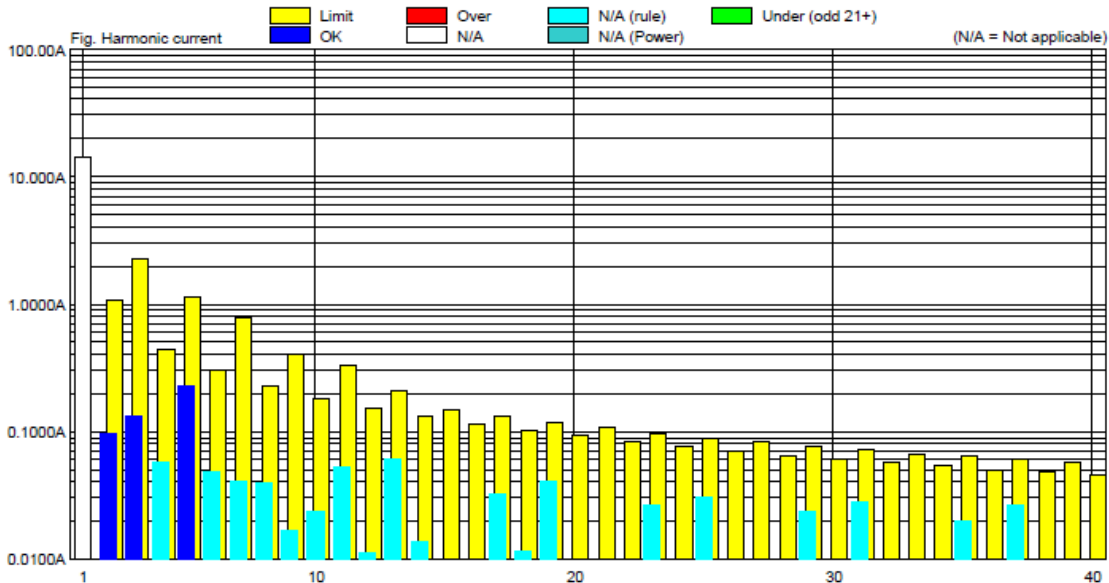



Test Report No.: CE200409N067

***** appliances (Maximum)

Print Date : Tue May 19 13:44:04 2020
 MeasureDate : Tue May 19 13:43:02 2020
 Comment : Experimental model Pattern A

Regulation : IEC61000-3-2 Ed3.0 am2
 IEC61000-4-7 Ed2.0 A1
 Class : CLASS A
 MeasureTime : 150.00sec
 Model : YOKOGAWA WT3000
 Rating Voltage : 230.00 V
 Wiring : 3P4W
 Element : 2(V)
 Range : 300V/100.0A
 Current(rms) : 14.5579 A
 Voltage(rms) : 230.40 V
 Frequency : 50.006 Hz
 Power Factor : 0.9996
 Beyond Limit Time : 15.0000 s
 Beyond Total Time : 0.0000 s
 THC : 0.3439 A

PASS

Set Fundamental I : -----
 Set Power Factor : -----
 Set P : -----
 Sigma W Max : 10008.98 W
 Sigma PF : 0.9997
 Distortion factor(V) : 0.06 %
 V THDS : 0.06 %
 V THDG : 0.06 %
 Distortion factor(A) : 2.54 %
 A THDS : 2.55 %
 A THDG : 2.55 %
 P THD : 0.00 %
 Power Limit : 75 W

Order	Measure[A]	Limit[A]	Margin[%]	Order	Measure[A]	Limit[A]	Margin[%]
1	14.5540			2	0.1093	1.6200	93.3
3	0.1481	3.4500	95.7	4	0.0712	0.6450	89.0
5	0.2514	1.7100	85.3	6	0.0580	0.4500	87.1
7	0.0521	1.1550	95.5	8	0.0475	0.3450	86.2
9	0.0250	0.6000	95.8	10	0.0273	0.2760	90.1
11	0.0589	0.4950	88.1	12	0.0157	0.2300	93.2
13	0.0657	0.3150	79.1	14	0.0179	0.1971	90.9
15	0.0147	0.2250	93.5	16	0.0060	0.1725	96.5
17	0.0379	0.1985	80.9	18	0.0143	0.1533	90.7
19	0.0434	0.1776	75.6	20	0.0119	0.1380	91.4
21	0.0126	0.1607	92.2	22	0.0059	0.1255	95.3
23	0.0301	0.1467	79.5	24	0.0067	0.1150	94.2
25	0.0324	0.1350	76.0	26	0.0074	0.1062	91.1
27	0.0086	0.1250	93.1	28	0.0043	0.0986	95.7
29	0.0269	0.1164	76.9	30	0.0054	0.0920	94.1
31	0.0295	0.1089	72.9	32	0.0060	0.0862	93.1
33	0.0061	0.1023	94.1	34	0.0049	0.0812	93.9
35	0.0231	0.0964	76.1	36	0.0053	0.0767	93.1
37	0.0274	0.0912	70.0	38	0.0054	0.0726	92.6
39	0.0069	0.0865	92.0	40	0.0043	0.0690	93.8

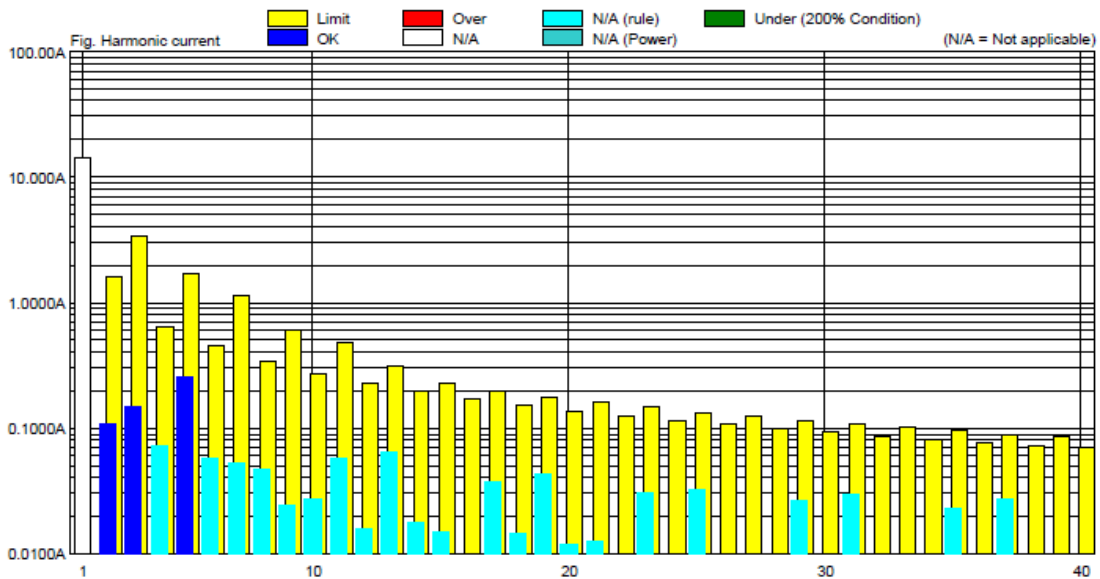



***** appliances (Average)

Print Date : Tue May 19 13:44:04 2020
MeasureDate : Tue May 19 13:43:02 2020
Comment : Experimental model Pattern A

Regulation : IEC61000-3-2 Ed3.0 am2
Class : CLASS A
MeasureTime : 150.00sec
Model : YOKOGAWA WT3000
Rating Voltage : 230.00 V
Wiring : 3P4W
Element : 3(W)
Range : 300V/100.0A
Current(rms) : 14.6174 A
Voltage(rms) : 230.44 V
Frequency : 50.000 Hz
Power Factor : 0.9997
POHC Limit : 0.2514 A
POHC Max : 0.0604 A
THC : 0.3083 A

PASS

Set Fundamental I : -----
Set Power Factor : -----
Set P : -----
Sigma W Max : 10008.98 W
Sigma PF : 0.9997
Distortion factor(V) : 0.05 %
V THDS : 0.05 %
V THDG : 0.05 %
Distortion factor(A) : 2.10 %
A THDS : 2.10 %
A THDG : 2.11 %
P THD : 0.00 %
Power Limit : 75 W

Table with 8 columns: Order, Measure[A], Limit[A], Margin[%], Order, Measure[A], Limit[A], Margin[%]. It lists harmonic data for orders 1 through 40, showing values for current and power, and their respective limits and margins.

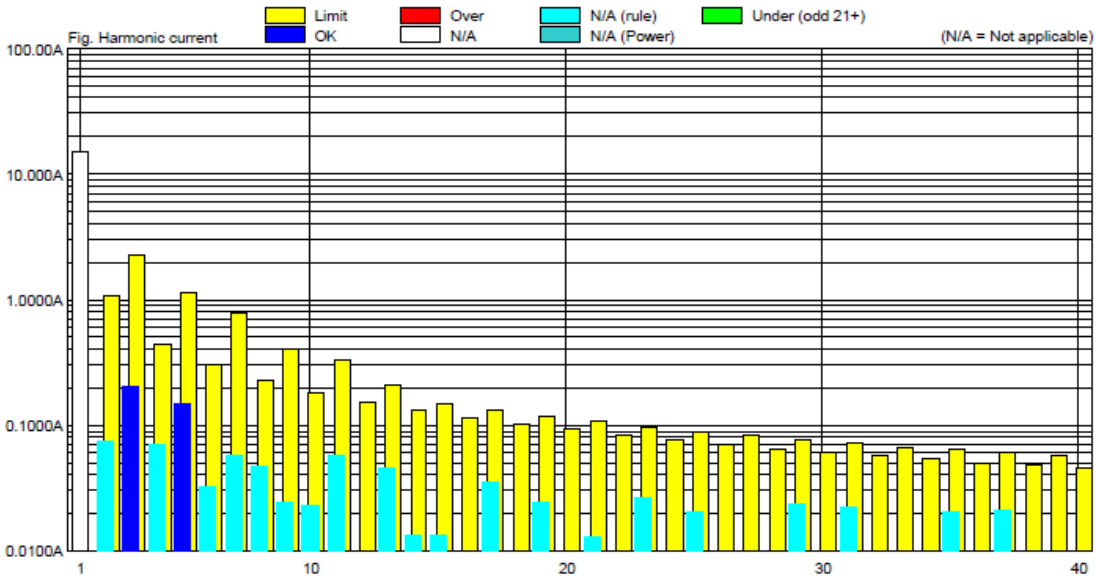



Test Report No.: CE200409N067

***** appliances (Maximum)

Print Date : Tue May 19 13:44:04 2020
 MeasureDate : Tue May 19 13:43:02 2020
 Comment : Experimental model Pattern A

Regulation : IEC61000-3-2 Ed3.0 am2
 IEC61000-4-7 Ed2.0 A1
 Class : CLASS A
 MeasureTime : 150.00sec
 Model : YOKOGAWA WT3000
 Rating Voltage : 230.00 V
 Wiring : 3P4W
 Element : 3(W)
 Range : 300V/100.0A
 Current(rms) : 14.6347 A
 Voltage(rms) : 230.46 V
 Frequency : 50.006 Hz
 Power Factor : 0.9998
 Beyond Limit Time : 15.0000 s
 Beyond Total Time : 0.0000 s
 THC : 0.3169 A

PASS

Set Fundamental I : -----
 Set Power Factor : -----
 Set P : -----
 Sigma W Max : 10008.98 W
 Sigma PF : 0.9997
 Distortion factor(V) : 0.06 %
 V THDS : 0.06 %
 V THDG : 0.06 %
 Distortion factor(A) : 2.23 %
 A THDS : 2.24 %
 A THDG : 2.26 %
 P THD : 0.00 %
 Power Limit : 75 W

Order	Measure[A]	Limit[A]	Margin[%]	Order	Measure[A]	Limit[A]	Margin[%]
1	14.6314			2	0.0872	1.6200	94.6
3	0.2153	3.4500	93.8	4	0.0815	0.6450	87.4
5	0.1659	1.7100	90.3	6	0.0469	0.4500	89.6
7	0.0669	1.1550	94.2	8	0.0562	0.3450	83.7
9	0.0376	0.6000	93.7	10	0.0286	0.2760	89.6
11	0.0637	0.4950	87.1	12	0.0114	0.2300	95.1
13	0.0483	0.3150	84.7	14	0.0156	0.1971	92.1
15	0.0176	0.2250	92.2	16	0.0083	0.1725	95.2
17	0.0382	0.1985	80.8	18	0.0086	0.1533	94.4
19	0.0266	0.1776	85.0	20	0.0094	0.1380	93.2
21	0.0160	0.1607	90.1	22	0.0060	0.1255	95.2
23	0.0293	0.1467	80.0	24	0.0057	0.1150	95.1
25	0.0230	0.1350	83.0	26	0.0077	0.1062	94.4
27	0.0113	0.1250	90.9	28	0.0054	0.0986	94.5
29	0.0262	0.1164	77.5	30	0.0045	0.0920	95.1
31	0.0244	0.1089	77.6	32	0.0057	0.0862	93.4
33	0.0095	0.1023	90.7	34	0.0048	0.0812	94.1
35	0.0234	0.0964	75.7	36	0.0044	0.0767	94.3
37	0.0232	0.0912	74.6	38	0.0052	0.0726	92.9
39	0.0088	0.0865	89.8	40	0.0054	0.0690	92.1

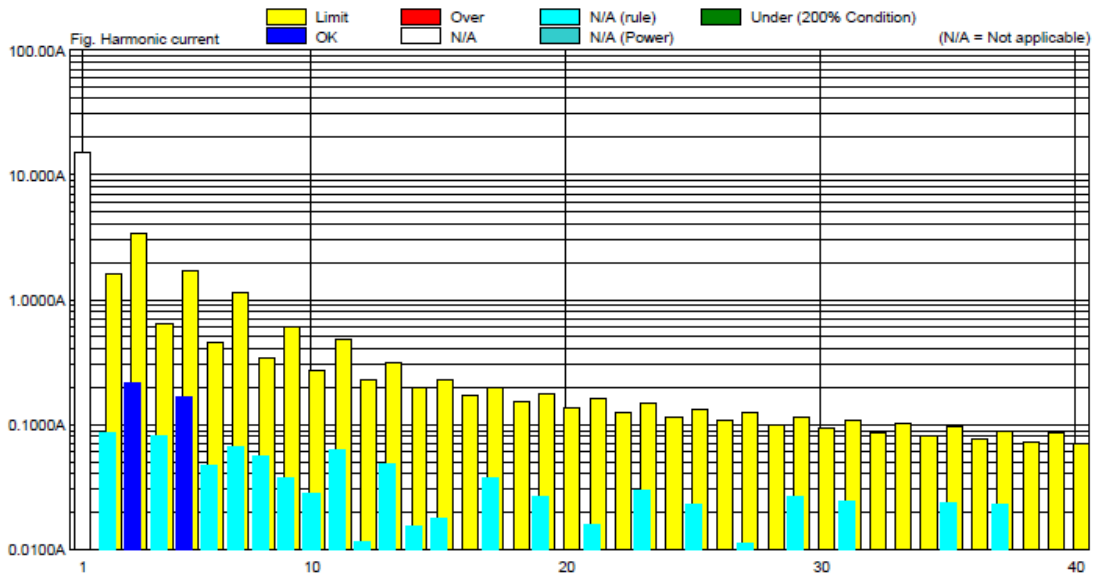



3.4 VOLTAGE FLUCTUATION AND FLICKS MEASUREMENT

3.4.1 LIMITS OF VOLTAGE FLUCTUATION AND FLICKS MEASUREMENT

TEST STANDARD: EN 61000-3-3

TEST ITEM	LIMIT	NOTE
P _{st}	1.0	P _{st} means short-term flicker indicator.
P _{lt}	0.65	P _{lt} means long-term flicker indicator.
T _{d(t)} (ms)	500	T _{d(t)} means maximum time that d(t) exceeds 3.3%.
d _{max} (%)	4	d _{max} means maximum relative voltage change.
dc (%)	3.3	dc means relative steady-state voltage change

TEST STANDARD: EN 61000-3-11

The test conditions specified in Annex A of EN 61000-3-3 shall be applicable to equipment rated ≤16A

The test impedance Z_{test} may be lower than Z_{ref}, particularly for equipment having a rated input current >16 A. To find the optimal test impedance, two conditions shall be met.

- firstly, the voltage drop, ΔU, caused by the equipment shall be within the range 3 % to 5 % of the test supply voltage;
- secondly, the ratio of inductive to resistive components of Z_{test} given by X_{test} / R_{test} shall be within the range 0,5 to 0,75 (i.e. similar to the ratio of the components of Z_{ref}).

NOTE The 3 % to 5 % condition ensures that the relative current changes of the equipment in the real network situation will be nearly the same as those during the test.

The test shall be made with the test circuit specified in Figure 1, except that the impedance Z_{ref} is replaced with Z_{test}. Four values d_{c test}, d_{max test}, P_{st test} and P_{lt test} shall be measured. The definitions of d_c, d_{max}, P_{st}, and P_{lt} are given in IEC 61000-3-3.



3.4.2 TEST INSTRUMENTS

Equipment	Manufacturer	Model No.	Serial No.	Last Cal.	Next Cal.
PRECISION POWER ANALYZER	YOKOGAWA	WT3000	91M210852	Sep. 11,19	Sep. 11,20
Test Software	YOKOGAWA	IEC61000	N/A	N/A	N/A
REFERENCE IMPEDANCE NETWORK	Voltech	EUR	3018	Sep. 11,19	Sep. 11,20

- NOTE:** 1. The test was performed in PV Room.
2. The calibration interval of the above test instruments is 12 months and the calibrations are traceable to CEPREI/CHINA, GRGT/CHINA and NIM/CHINA.

3.4.3 TEST PROCEDURE

- a. The EUT was placed on the top of a wooden table 0.8 meters above the ground and operated to produce the most unfavorable sequence of voltage changes under normal operating conditions.
- b. During the flick measurement, the measure time shall include that part of whole operation cycle in which the EUT produce the most unfavorable sequence of voltage changes. The observation period for short-term flicker indicator is 10 minutes and the observation period for long-term flicker indicator is 2 hours.



3.4.4 DEVIATION FROM TEST STANDARD

No deviation

3.4.5 TEST SETUP

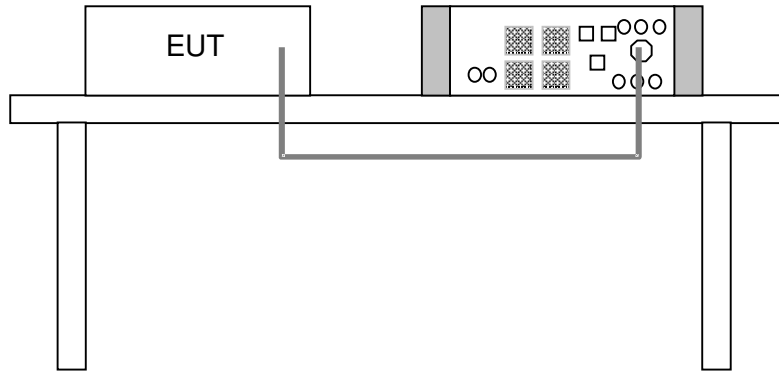

3.4.6 EUT OPERATING CONDITIONS

Same as item 3.1.6



3.4.7 TEST RESULTS

Model: HYD 20KTL-3PH

Regulation : IEC61000-3-11 Ed1.0
 IEC61000-4-15 Ed1.1
 Interval : 10Min0Sec
 Model : YOKOGAWA WT3000
 Wiring : three-phase 4wire
 Voltage Range : 600.00V
 Voltage U1 : 238.70V
 Set Frequency : 50Hz
 Frequency U1 : 50.000Hz
 Element : 1
 dmin : 0.10%

PASS

Compatibility Condition : Compliance with IEC61000-3-3
 Element1 : Pass
 dc (3.30%) : Pass
 dmax (4.00%) : Pass
 d(t) (500ms) : Pass
 Pst (1.00) : Pass
 Pit (0.65) : Pass

No.	dc[%]	dmax[%]	d(t)[ms]	Pst
1	0.09	0.31	0.00	0.26
2	0.09	0.30	0.00	0.25
3	0.10	0.30	0.00	0.24
4	0.09	0.30	0.00	0.24
5	0.10	0.30	0.00	0.26
6	0.09	0.31	0.00	0.24
7	0.10	0.32	0.00	0.27
8	0.09	0.34	0.00	0.25
9	0.09	0.32	0.00	0.24
10	0.09	0.34	0.00	0.24
11	0.09	0.32	0.00	0.26
12	0.09	0.33	0.00	0.27

Pit
0.25

Regulation : IEC61000-3-11 Ed1.0
 IEC61000-4-15 Ed1.1
 Interval : 10Min0Sec
 Model : YOKOGAWA WT3000
 Wiring : three-phase 4wire
 Voltage Range : 600.00V
 Voltage U2 : 239.54V
 Set Frequency : 50Hz
 Frequency U2 : 50.000Hz
 Element : 2
 dmin : 0.10%

PASS

Compatibility Condition : Compliance with IEC61000-3-3
 Element2 : Pass
 dc (3.30%) : Pass
 dmax (4.00%) : Pass
 d(t) (500ms) : Pass
 Pst (1.00) : Pass
 Pit (0.65) : Pass

No.	dc[%]	dmax[%]	d(t)[ms]	Pst
1	0.11	0.47	0.00	0.28
2	0.09	0.48	0.00	0.26
3	0.09	0.50	0.00	0.26
4	0.08	0.51	0.00	0.26
5	0.09	0.54	0.00	0.28
6	0.06	0.55	0.00	0.27
7	0.05	0.57	0.00	0.30
8	0.07	0.58	0.00	0.27
9	0.07	0.57	0.00	0.27
10	0.06	0.60	0.00	0.26
11	0.05	0.59	0.00	0.31
12	0.08	0.56	0.00	0.31

Pit
0.28



**BUREAU
VERITAS**

Test Report No.: CE200409N067

Regulation : IEC61000-3-11 Ed1.0
 IEC61000-4-15 Ed1.1
 Interval : 10Min0Sec
 Model : YOKOGAWA WT3000
 Wiring : three-phase 4wire
 Voltage Range : 600.00V
 Voltage U3 : 239.60V
 Set Frequency : 50Hz
 Frequency U3 : Error
 Element : 3
 dmin : 0.10%

PASS

Compatibility Condition : Compliance with IEC61000-3-3
 Element3 : Pass
 dc (3.30%) : Pass
 dmax (4.00%) : Pass
 d(t) (500ms) : Pass
 Pst (1.00) : Pass
 Pit (0.65) : Pass

No.	dc[%]	dmax[%]	d(t)[ms]	Pst
1	0.09	0.32	0.00	0.28
2	0.14	0.32	0.00	0.27
3	0.10	0.29	0.00	0.28
4	0.10	0.33	0.00	0.28
5	0.09	0.35	0.00	0.30
6	0.10	0.36	0.00	0.28
7	0.09	0.33	0.00	0.31
8	0.11	0.39	0.00	0.28
9	0.11	0.37	0.00	0.28
10	0.09	0.36	0.00	0.28
11	0.09	0.39	0.00	0.31
12	0.07	0.40	0.00	0.32
			Pit	0.29



Model: HYD 10KTL-3PH

Regulation : IEC61000-3-3 Ed2.0
 IEC61000-4-15 Ed1.1
 Interval : 10Min0Sec
 Model : YOKOGAWA WT3000
 Wiring : three-phase 4wire
 Voltage Range : 600.00V
 Voltage U1 : 234.35V
 Set Frequency : 50Hz
 Frequency U1 : 50.001Hz
 Element : 1
 dmin : 0.10%

PASS

Element1 : Pass
 dc (3.30%) : Pass
 dmax (4.00%) : Pass
 d(t) (500ms) : Pass
 Pst (1.00) : Pass
 Plt (0.65) : Pass

No.	dc[%]	dmax[%]	d(t)[ms]	Pst
1	0.12	0.14	0.00	0.11
2	0.10	0.15	0.00	0.11
3	0.10	0.16	0.00	0.11
4	0.11	0.35	0.00	0.11
5	0.11	0.17	0.00	0.11
6	0.11	0.16	0.00	0.11
7	0.12	0.16	0.00	0.11
8	0.12	0.16	0.00	0.11
9	0.12	0.16	0.00	0.11
10	0.08	0.16	0.00	0.11
11	0.10	0.15	0.00	0.11
12	0.09	0.16	0.00	0.11

Plt
0.11

Regulation : IEC61000-3-3 Ed2.0
 IEC61000-4-15 Ed1.1
 Interval : 10Min0Sec
 Model : YOKOGAWA WT3000
 Wiring : three-phase 4wire
 Voltage Range : 600.00V
 Voltage U3 : 234.78V
 Set Frequency : 50Hz
 Frequency U3 : Error
 Element : 3
 dmin : 0.10%

PASS

Element3 : Pass
 dc (3.30%) : Pass
 dmax (4.00%) : Pass
 d(t) (500ms) : Pass
 Pst (1.00) : Pass
 Plt (0.65) : Pass

No.	dc[%]	dmax[%]	d(t)[ms]	Pst
1	0.13	0.18	0.00	0.11
2	0.13	0.17	0.00	0.12
3	0.09	0.25	0.00	0.12
4	0.08	0.35	0.00	0.12
5	0.08	0.27	0.00	0.12
6	0.09	0.18	0.00	0.11
7	0.10	0.17	0.00	0.12
8	0.09	0.27	0.00	0.12
9	0.13	0.18	0.00	0.11
10	0.09	0.26	0.00	0.12
11	0.09	0.24	0.00	0.12
12	0.09	0.27	0.00	0.12

Plt
0.12



Regulation : IEC61000-3-3 Ed2.0
 IEC61000-4-15 Ed1.1
 Interval : 10Min0Sec
 Model : YOKOGAWA WT3000
 Wiring : three-phase 4wire
 Voltage Range : 600.00V
 Voltage U2 : 234.95V
 Set Frequency : 50Hz
 Frequency U2 : 50.000Hz
 Element : 2
 dmin : 0.10%

PASS

Element2 : Pass
 dc (3.30%) : Pass
 dmax (4.00%) : Pass
 d(t) (500ms) : Pass
 Pst (1.00) : Pass
 PIt (0.65) : Pass

No.	dc[%]	dmax[%]	d(t)[ms]	Pst
1	0.11	0.29	0.00	0.11
2	0.11	0.29	0.00	0.12
3	0.10	0.29	0.00	0.12
4	0.10	0.43	0.00	0.13
5	0.09	0.27	0.00	0.12
6	0.09	0.27	0.00	0.11
7	0.10	0.27	0.00	0.12
8	0.09	0.18	0.00	0.12
9	0.11	0.27	0.00	0.11
10	0.11	0.19	0.00	0.11
11	0.09	0.26	0.00	0.12
12	0.11	0.25	0.00	0.12
				PIt
				0.12



4 IMMUNITY TEST

4.1 GENERAL DESCRIPTION

4.1.1 GENERAL DESCRIPTION OF EN 61000-6-2

Product Standard:	EN 61000-6-2:2005	
Basic Standard, specification requirement, and Performance Criteria:	IEC 61000-4-2	Electrostatic Discharge – ESD: 4kV Contact discharge, 8kV air discharge, Performance Criterion B
	IEC 61000-4-3	Radio-Frequency Electromagnetic Field Susceptibility Test – RS: 80-1000 MHz, 10V/m, 80% AM (1kHz), 1400-2000 MHz, 3V/m, 80% AM (1kHz) 2000-2700 MHz, 1V/m, 80% AM (1kHz) Performance Criterion A
	IEC 61000-4-4	Electrical Fast Transient/Burst - EFT AC Power line: 2kV, DC Power line: 2kV Signal line: 1kV Performance Criterion B
	IEC 61000-4-5	Surge Immunity Test: 1.2/50 us Open Circuit Voltage, 8 /20 us Short Circuit Current, AC Power Line: line to line 1 kV, line to earth 2kV DC Power Line: line to line 0.5kV line to earth 0.5kV Signal line: 1kV Performance Criterion B
	IEC 61000-4-6	Conducted Radio Frequency Disturbances Test – CS:0.15-80 MHz, 10Vrms, 80% AM, 1kHz, Performance Criterion A
	IEC 61000-4-8	Power Frequency Magnetic Field Test, 50/60 Hz, 30A/m, Performance Criterion A



4.1.2 PERFORMANCE CRITERIA

According to Clause 4 of EN 61000-6-2:2005 standard, the following describes the general performance criteria.

CRITERION A	The apparatus shall continue to operate as intended during and after the test. No degradation of performance or loss of function is allowed below a performance level specified by the manufacturer, when the apparatus is used as intended. The performance level may be replaced by a permissible loss of performance. If the minimum performance level or the permissible performance loss is not specified by the manufacturer, either of these may be derived from the product description and documentation and what the user may reasonably expect from the apparatus if used as intended.
CRITERION B	The apparatus shall continue to operate as intended after the test. No degradation of performance or loss of function is allowed below a performance level specified by the manufacturer, when the apparatus is used as intended. The performance level may be replaced by a permissible loss of performance. During the test, degradation of performance is however allowed. No change of actual operating state or stored data is allowed. If the minimum performance level or the permissible performance loss is not specified by the manufacturer, either of these may be derived from the product description and documentation and what the user may reasonably expect from the apparatus if used as intended.
CRITERION C	Temporary loss of function is allowed, provided the function is self-recoverable or can be restored by the operation of the controls.

4.1.3 EUT OPERATING CONDITION

Same as item 3.1.6



4.2 ELECTROSTATIC DISCHARGE IMMUNITY TEST (ESD)

4.2.1 TEST SPECIFICATION

Basic Standard:	IEC 61000-4-2
Discharge Impedance:	330 ohm / 150 pF
Discharge Voltage:	Air Discharge: 8 kV (Direct) Contact Discharge: 4 kV (Indirect)
Polarity:	Positive & Negative
Number of Discharge:	20 times at each test point
Discharge Mode:	Single Discharge
Discharge Period:	1 second

4.2.2 TEST INSTRUMENTS

Equipment	Manufacturer	Model No.	Serial No.	Last Cal.	Next Cal.
ESD Generator	TESEQ	NSG 437	279	Mar. 06,20	Mar. 05,21
Test Software	TESEQ	V03.03	N/A	N/A	N/A
ESD Generator	EM TEST	Dito	V1211112265	Nov. 30,19	Nov. 29,20
Test Software	EM TEST	V 2.31	N/A	N/A	N/A

- NOTE:** 1. The test was performed in ESD Room.
2. The calibration interval of the above test instruments is 12 months and the calibrations are traceable to CEPREI/CHINA, GRGT/CHINA and NIM/CHINA.



4.2.3 TEST PROCEDURE

The basic test procedure was in accordance with IEC 61000-4-2:

- a. Electrostatic discharges were applied only to those points and surfaces of the EUT that are accessible to users during normal operation.
- b. The test was performed with at least ten single discharges on the pre-selected points in the most sensitive polarity.
- c. The time interval between two successive single discharges was at least 1 second.
- d. The discharge return cable of the generator shall be kept at a distance of at least 0.2 m from the EUT whilst the discharge is being applied and should not be held by the operator.
- e. Contact discharges were applied to the non-insulating coating, with the pointed tip of the generator penetrating the coating and contacting the conducting substrate.
- f. Air discharges were applied with the round discharge tip of the discharge electrode approaching the EUT as fast as possible (without causing mechanical damage) to touch the EUT. After each discharge, the ESD generator was removed from the EUT and re-triggered for a new single discharge. The test was repeated until all discharges were complete.
- g. At least ten single discharges (in the most sensitive polarity) were applied to the **Horizontal Coupling Plane** at points on each side of the EUT. The ESD generator was positioned horizontal at a distance of 0.1 meters from the EUT with the discharge electrode touching the **HCP**.
- h. At least ten single discharges (in the most sensitive polarity) were applied to the center of one vertical edge of the **Vertical Coupling Plane** in sufficiently different positions that the four faces of the EUT were completely illuminated. The **VCP** (dimensions 0.5m x 0.5m) was placed vertically to and 0.1 meters from the EUT.

4.2.4 DEVIATION FROM TEST STANDARD

No Deviation

4.2.5 TEST SETUP

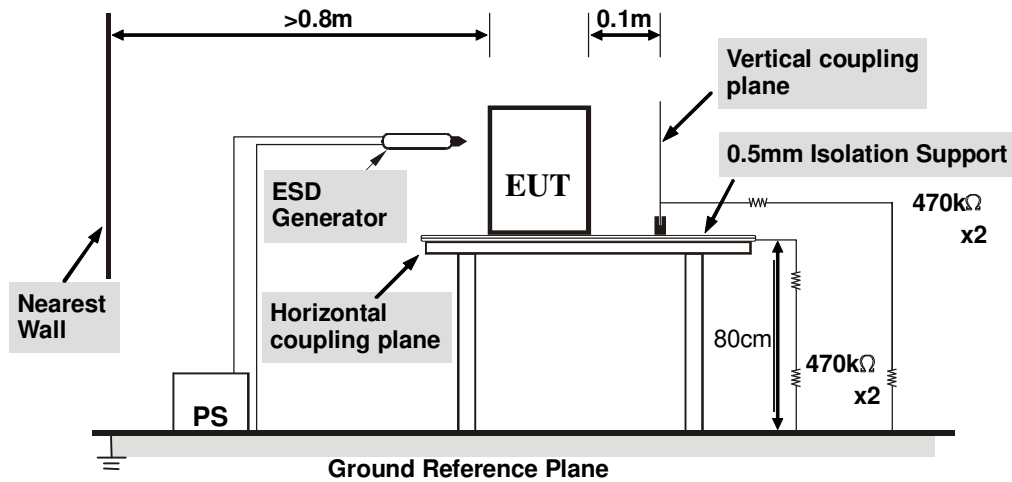

NOTE:

TABLE-TOP EQUIPMENT

The configuration consisted of a wooden table 0.8 meters high standing on the **Ground Reference Plane**. The **GRP** consisted of a sheet of aluminum at least 0.25mm thick, and 2.5 meters square connected to the protective grounding system. A **Horizontal Coupling Plane** (1.6m x 0.8m) was placed on the table and attached to the **GRP** by means of a cable with 940kΩ total impedance. The equipment under test, was installed in a representative system as described in section 7 of IEC 61000-4-2, and its cables were placed on the **HCP** and isolated by an insulating support of 0.5mm thickness. A distance of 0.8-meter minimum was provided between the EUT and the walls of the laboratory and any other metallic structure.

FLOOR-STANDING EQUIPMENT

The equipment under test was installed in a representative system as described in section 7 of IEC 61000-4-2, and its cables were isolated from the Ground Reference Plane by an insulating support of 0.1-meter thickness. The GRP consisted of a sheet of aluminum that is at least 0.25mm thick, and 2.5 meters square connected to the protective grounding system and extended at least 0.5 meters from the EUT on all sides.



4.2.6 TEST RESULTS

TEST MODE	See section 2.2	TEST VOLTAGE	See section 2.2
ENVIRONMENTAL CONDITIONS	24deg. C, 54% RH 101.3kPa	TESTED BY: Dragon	

Direct Discharge Application				
Test Level (kV)	Polarity	Test Point	Test Result of Contact Discharge	Test Result of Air Discharge
4	+/-	All Metal Part	A	N/A
8	+/-	All Non-metal Part	N/A	A

Indirect Discharge Application				
Discharge Level (kV)	Polarity	Test Point	Test Result of HCP	Test Result of VCP
4	+/-	HCP	A	N/A
4	+/-	VCP	N/A	A

NOTE: A: There was no change compared with initial operation during the test.



ESD TEST POINT

(○ - Direct Contact Discharge; ✦ - Air Discharge)





4.3 RADIATED, RADIO-FREQUENCY, ELECTROMAGNETIC FIELD IMMUNITY TEST (RS)

4.3.1 TEST SPECIFICATION

Basic Standard:	IEC 61000-4-3
Frequency Range:	80-1000MHz, 1400-2000MHz, 2000-2700MHz
Field Strength:	10V/m, 3V/m, 1V/m
Modulation:	1kHz Sine Wave, 80%, AM Modulation
Frequency Step:	1 % of fundamental
Polarity of Antenna:	Horizontal and Vertical
Antenna Height:	1.5m
Dwell Time:	at least 3 seconds

4.3.2 TEST INSTRUMENTS

Equipment	Manufacturer	Model No.	Serial No.	Last Cal.	Next Cal.
Signal Generator	Agilent	N5181A	MY50142530	Sep. 12,19	Sep. 11,20
Antenna Log-Periodic	AR	ATR80M6G	0337307	N/A	N/A
Antenna Log-Periodic	AR	ATS700M11G	0336821	N/A	N/A
Switch Controller	AR	SC1000	0337343	N/A	N/A
RF Power Meter	Boonton	4242	13984	Sep. 12,19	Sep. 11,20
Power Sensor	Boonton	51011EMC	35716	Sep. 12,19	Sep. 11,20
Power Sensor	Boonton	51011EMC	35715	Sep. 12,19	Sep. 11,20
E-Field probe	Narda	NBM-520	2403/01B	Dec. 24,19	Dec. 23,20
Power Amplifier	TESEQ	CBA 1G-150	T44029	N/A	N/A
Power Amplifier	TESEQ	CBA 3G-100	T44030	N/A	N/A
Power Amplifier	TESEQ	CBA 6G-050	1041204	N/A	N/A
Dual Directional Coupler	TESEQ	C5982	95208	Sep. 21,19	Sep. 20,20
Dual Directional Coupler	TESEQ	C6187	95175	Sep. 21,19	Sep. 20,20
Dual Directional Coupler	TESEQ	CPH-274F	M251304-01	Sep. 21,19	Sep. 20,20
Audio analyzer	Rohde&Schwarz	UPV	101397	Sep. 18,19	Sep. 17,20
Conditioning Amplifier	B&K	2690A0S2	2437856	Oct. 18,19	Oct. 17,20
EAR SIMULATOR	B&K	4192	2764719	Jun. 01,19	May 30,20
Test Software	Tonscend	TS+	2.0.1.8	N/A	N/A
Test Software	ADT	BVADT_RS_V 7.6.4-DG	N/A	N/A	N/A

NOTE: 1. The test was performed in RS chamber.
 2. The calibration interval of the above test instruments is 12 months and the calibrations are traceable to CEPREI/CHINA, GRGT/CHINA and NIM/CHINA.



4.3.3 TEST PROCEDURE

The test procedure was in accordance with IEC 61000-4-3

- a. The testing was performed in a fully-anechoic chamber.
- b. The frequency range is swept from 80 MHz to 1000 MHz, 1400MHz to 2000MHz, 2000MHz to 2700MHz with the signal 80% amplitude modulated with a 1kHz sine wave.
- c. The dwell time at each frequency shall not be less than the time necessary for the EUT to be exercised and to respond, but shall in no case be less than 0,5s.
- d. The field strength levels were 10V/m, 3V/m, 1V/m.
- e. The test was performed with the EUT exposed to both vertically and horizontally polarized fields on each of the four sides.

4.3.4 DEVIATION FROM TEST STANDARD

No Deviation



4.3.5 TEST SETUP

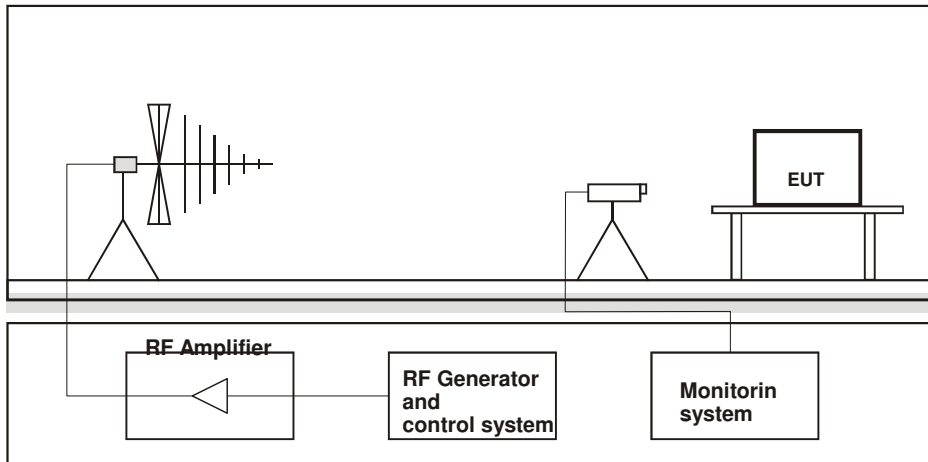

NOTE:

TABLETOP EQUIPMENT

The EUT installed in a representative system as described in section 7 of IEC 61000-4-3 was placed on a non-conductive table 0.8 meters in height. The system under test was connected to the power and signal wire according to relevant installation instructions.

FLOOR STANDING EQUIPMENT

The EUT installed in a representative system as described in section 7 of IEC 61000-4-3 was placed on a non-conductive wood support 0.1 meters in height. The system under test was connected to the power and signal wire according to relevant installation instructions.



4.3.6 TEST RESULTS

TEST MODE	See section 2.2	TEST VOLTAGE	See section 2.2
ENVIRONMENTAL CONDITIONS	23deg. C, 53% RH	TESTED BY: Andy	

Field Strength (V/m)	Test Frequency Note#1 (MHz)	Polarization of antenna (Horizontal / Vertical)	Test Distance (m)	Test Result	Remark
10	80 - 1000	H&V	3	A	N/A
3	1400 - 2000	H&V	3	A	N/A
1	2000 - 2700	H&V	3	A	N/A

Note#1:

Tested Israel SII Frequencies 89,100,107,144,163,196,244,315,434,460,600,825,845,880 MHz

NOTE: A: There was no change compared with initial operation during the test.



4.4 ELECTRICAL FAST TRANSIENT/BURST IMMUNITY TEST (EFT)

4.4.1 TEST SPECIFICATION

Basic Standard:	IEC 61000-4-4
Test Voltage:	Power Line: 2kV
Polarity:	Positive & Negative
Impulse Frequency:	5 kHz
Impulse Waveshape :	5/50 ns
Burst Duration:	15 ms
Burst Period:	300 ms
Test Duration:	1 min.

4.4.2 TEST INSTRUMENTS

Equipment	Manufacturer	Model No.	Serial No.	Last Cal.	Next Cal.
EFT Module	TESEQ	NSG 3060 Mainframe	1404	Mar. 25,20	Mar. 24,21
Automated 3- Phase Coupling/ Decoupling Network	TESEQ	CDN 3063	2131	Mar. 25,20	Mar. 24,21
EFT Coupling Clamp	HAEFELY	IP4A	150407	Mar. 18,20	Mar. 17,21
Test Software	TESEQ	CDM 3061_0002.30	1361	N/A	N/A
Test Software	TESEQ	HVM 3060_0002.30	293	N/A	N/A

NOTE: 1. The test was performed in EMS Room.
 2. The calibration interval of the above test instruments is 12 months and the calibrations are traceable to CEPREI/CHINA, GRGT/CHINA and NIM/CHINA.

4.4.3 TEST PROCEDURE

- a. Both positive and negative polarity discharges were applied.
- b. The length of the “hot wire” from the coaxial output of the EFT generator to the terminals on the EUT should not exceed 0.5 meter ± 0.05 meter.
- c. The duration time of each test sequential was 1 minute.
- d. The transient/burst waveform was in accordance with IEC 61000-4-4, 5/50ns.

4.4.4 DEVIATION FROM TEST STANDARD

No deviation.

4.4.5 TEST SETUP

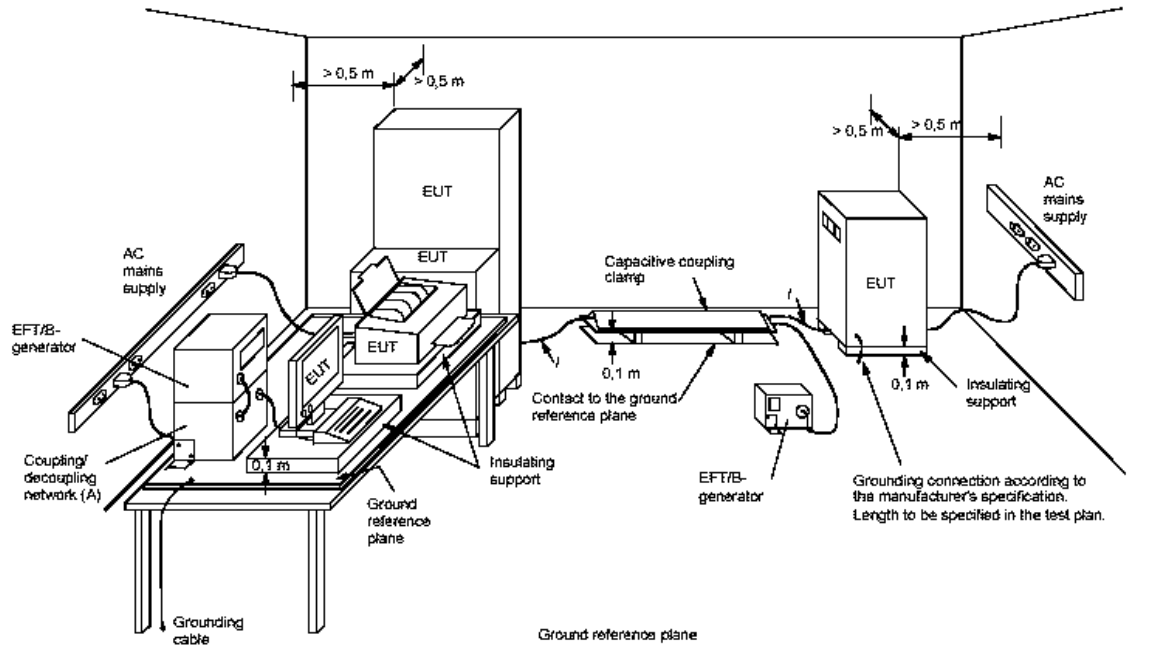

NOTE:

TABLETOP EQUIPMENT

The configuration consisted of a wooden table standing on the Ground Reference Plane and should be located 0.1m +/- 0.01m above the Ground Reference Plane.

The GRP consisted of a sheet of aluminum (at least 0.25mm thick and 2.5m square) connected to the protective grounding system. A minimum distance of 0.5m was provided between the EUT and the walls of the laboratory or any other metallic structure.

FLOOR STANDING EQUIPMENT

The EUT installed in a representative system as described in section 7 of IEC 61000-4-4 and its cables, were isolated from the Ground Reference Plane by an insulating support that is 0.1-meter thick. The GRP consisted of a sheet of aluminum (at least 0.25mm thick and 2.5m square) connected to the protective grounding system.



4.4.6 TEST RESULTS

TEST MODE	See section 2.2	TEST VOLTAGE	See section 2.2
ENVIRONMENTAL CONDITIONS	21.9 deg. C, 53.5% RH	TESTED BY: Wang	

Pulse Voltage Pulse Polarity	1.0 kV		2.0 kV		kV	
	+	-	+	-	+	-
L1+L2+L3 + N + PE	/	/	A	A	/	/
L1+L2+L3	/	/	A	A	/	/
N	/	/	A	A	/	/
PE	/	/	A	A	/	/
L1+L2+L3+PE	/	/	A	A	/	/
N+PE	/	/	A	A	/	/
PV+, PV-, PE	/	/	A	A	/	/

NOTE: A: There was no change compared with initial operation during the test.



4.5 SURGE IMMUNITY TEST

4.5.1 TEST SPECIFICATION

Basic Standard:	IEC 61000-4-5
Wave-Shape:	Combination Wave 1.2/50 us Open Circuit Voltage 8 /20 us Short Circuit Current
Test Voltage:	DC/AC Power Line : Line to Line:1kV Line to PE:2kV
Surge Input/Output:	L-N&L-PE&N-PE
Generator Source Impedance:	2ohm between networks 12 ohm between network and ground
Polarity:	Positive/Negative
Phase Angle:	0° /90°/180°/270°
Pulse Repetition Rate:	1 time / 60 sec.
Number of Tests:	5 positive and 5 negative at selected points

4.5.2 TEST INSTRUMENTS

Equipment	Manufacturer	Model No.	Serial No.	Last Cal.	Next Cal.
Telecom Surge Module	TESEQ	NSG 3060 Mainframe	1404	Mar. 25,20	Mar. 24,21
Automated 3- Phase Coupling/ Decoupling Network	TESEQ	CDN 3063	2131	Mar. 25,20	Mar. 24,21
CDN	TESEQ	CDN HSS-2	34275	Mar. 25,20	Mar. 24,21
CDN	TESEQ	CDN 118	30741	Mar. 25,20	Mar. 24,21
Test Software	TESEQ	CDM 3061_0002.30	1361	N/A	N/A
Test Software	TESEQ	HVM 3060_0002.30	293	N/A	N/A

- NOTE:** 1. The test was performed in EMS Room.
2. The calibration interval of the above test instruments is 12 months and the calibrations are traceable to CEPREI/CHINA, GRGT/CHINA and NIM/CHINA.



4.5.3 TEST PROCEDURE

a. For EUT power supply:

The surge is to be applied to the EUT power supply terminals via the capacitive coupling network. Decoupling networks are required in order to avoid possible adverse effects on equipment not under test that may be powered by the same lines, and to provide sufficient decoupling impedance to the surge wave. The power cord between the EUT and the coupling/decoupling networks shall be 2 meters in length (or shorter).

b. For test applied to unshielded unsymmetrically operated interconnection lines of EUT:

The surge is applied to the lines via the capacitive coupling. The coupling / decoupling networks shall not influence the specified functional conditions of the EUT. The interconnection line between the EUT and the coupling/decoupling networks shall be 2 meters in length (or shorter).

c. For test applied to unshielded symmetrically operated interconnection / telecommunication lines of EUT:

The surge is applied to the lines via gas arrestors coupling. Test levels below the ignition point of the coupling arrestor cannot be specified. The interconnection line between the EUT and the coupling/decoupling networks shall be 2 meters in length (or shorter).

4.5.4 DEVIATION FROM TEST STANDARD

No deviation.

4.5.5 TEST SETUP

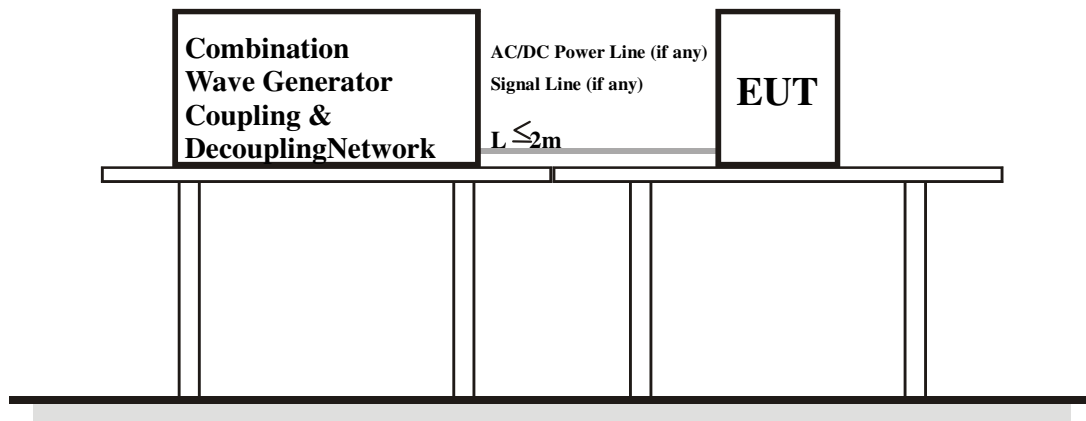



4.5.6 TEST RESULTS

TEST MODE	See section 2.2	TEST VOLTAGE	See section 2.2
ENVIRONMENTAL CONDITIONS	23.9eg. C, 52.7% RH	TESTED BY: Walker	

AC/DC Power port:

\Phase angle \ Test result \Voltage (Kv) \ Test point\ Polarity		0°	90°	180°	270°	Test point	DC Power Port
1	L1-N	+	B	A	A	PV+ - PV-	A
		-	A	A	A		A
1	L2-N	+	A	A	A	/	/
		-	A	A	A	/	/
1	L3-N	+	A	A	A	/	/
		-	A	A	A	/	/
2	L1-PE	+	A	A	A	PV+ - PE	A
		-	A	A	A		A
2	L2-PE	+	A	A	A	PV- - PE	A
		-	A	A	A		A
2	L3-PE	+	A	A	A	/	/
		-	A	A	A	/	/
2	N-PE	+	A	A	A	/	/
		-	A	A	A	/	/

NOTE: A: There was no change compared with initial operation during the test.



4.6 IMMUNITY TO CONDUCTED DISTURBANCES INDUCED BY RF FIELDS (CS)

4.6.1 TEST SPECIFICATION

Basic Standard:	IEC 61000-4-6
Frequency Range:	0.15 MHz - 80 MHz
Field Strength:	10V _{r.m.s}
Modulation:	1kHz Sine Wave, 80%, AM Modulation
Frequency Step:	1 % of fundamental
Coupled Cable:	Power Mains & DC Power Line
Coupling Device:	CDN-M532, Clamp

4.6.2 TEST INSTRUMENTS

Equipment	Manufacturer	Model No.	Serial No.	Last Cal.	Next Cal.
Signal Generator	Rohde&Schwarz	SMB 100A	102382	Mar. 18,20	Mar. 17,21
CDN	Luthi	L-801M2/M3	2015	Sep. 18,19	Sep. 17,20
CDN(AUX)	TESEQ	CDN M016	27452	Sep. 18,19	Sep. 17,20
CDN	TESEQ	T200A	26944	Mar. 18,20	Mar. 17,21
CDN	TESEQ	ST08A	32256	Mar. 18,20	Mar. 17,21
CDN	TESEQ	T800	28623	May 14, 20	May 13, 21
CDN	FCC	FCC-801-T8-S RJ45	160168	Sep. 18,19	Sep. 17,20
CDN	TESEQ	CDN M532	37300	Sep. 18,19	Sep. 17,20
6dB 150Watt Attenuator	Bird	150-A-FFN-06	1507	Sep. 18,19	Sep. 17,20
Bulk Current Injection Probe	FCC	F-120-9A	160053	Sep. 18,19	Sep. 17,20
Power Amplifier	PRANA	DR 220	1512-1788	NA	NA
Electromagnetic Injection Clamp	Luthi	EM101	35640	Sep. 25,19	Sep. 24,20
Audio analyzer	Rohde&Schwarz	UPV	101397	Sep. 18,19	Sep. 17,20
Conditioning Amplifier	B&K	2690A0S2	2437856	Oct. 18,19	Oct. 17,20
EAR SIMULATOR	B&K	4192	2764719	Jun. 01,19	May 30,20
Test Software	Tonscend	TS+	2.0.1.7	N/A	N/A
Test Software	ADT	BVADT_CS_V 7.6.2	N/A	N/A	N/A

- NOTE:** 1. The test was performed in CS test room.
 2. The calibration interval of the above test instruments is 12 months and the calibrations are traceable to CEPREI/CHINA, GRGT/CHINA and NIM/CHINA.



4.6.3 TEST PROCEDURE

- a. The EUT shall be tested within its intended operating and climatic conditions.
- b. An artificial hand was placed on the hand-held accessory and connected to the ground reference plane.
- c. The test shall be performed with the test generator connected to each of the coupling and decoupling devices in turn, while the other non-excited RF input ports of the coupling devices are terminated by a 50-ohm load resistor.
- d. The frequency range is swept from 150 kHz to 80 MHz, using the signal level established during the setting process and with a disturbance signal of 80 % amplitude. The signal is modulated with a 1 kHz sine wave, pausing to adjust the RF signal level or the switch coupling devices as necessary. Where the frequency is swept incrementally, the step size shall not exceed 1 % of the preceding frequency value.
- e. The dwell time of the amplitude modulated carrier at each frequency shall not be less than the time necessary for the EUT to be exercised and to respond, but shall in no case be less than 0,5 s. The sensitive frequencies (e.g. clock frequencies) shall be analyzed separately.
- f. Attempts should be made to fully exercise the EUT during testing, and to fully interrogate all exercise modes selected for susceptibility.

4.6.4 DEVIATION FROM TEST STANDARD

No deviation.



4.6.5 TEST SETUP

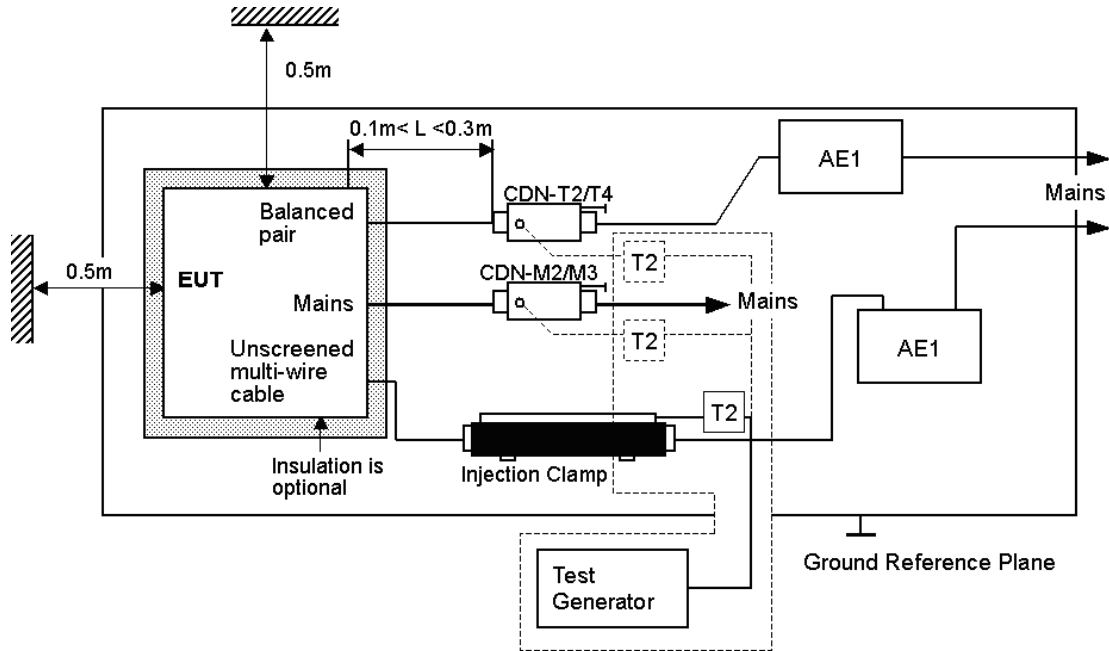

NOTE: The EUT clearance from any metallic obstacles shall be at least 0.5m.
All non-excited input ports of the CDNs shall be terminated by 50Ω loads.

NOTE:

FLOOR-STANDING EQUIPMENT

The equipment to be tested is placed on an insulating support of 0.1 meters height above a ground reference plane. All relevant cables shall be provided with the appropriate coupling and decoupling devices at a distance between 0.1 meters and 0.3 meters from the projected geometry of the EUT on the ground reference plane.



4.6.6 TEST RESULTS

TEST MODE	See section 2.2	TEST VOLTAGE	See section 2.2
ENVIRONMENTAL CONDITIONS	22deg. C, 54% RH	TESTED BY: Andy	

Voltage (V)	Test Frequency Note#1 (MHz)	Tested Line	Injection Method.	Test Result	Remark
10	0.15 – 80	AC Line	CDN-M532	A	N/A
10	0.15 – 80	DC Line	Clamp	A	N/A

Note#1: Tested Israel SII Frequencies 0.2,0.53,1,1.5,7.1,13.56,21,27.12,40.68,65,68 MHz

NOTE: A: There was no change compared with initial operation during the test.



4.7 POWER FREQUENCY MAGNETIC FIELD IMMUNITY TEST

4.7.1 TEST SPECIFICATION

Basic Standard:	IEC 61000-4-8
Frequency Range:	50/60Hz
Field Strength:	30A/m
Observation Time:	5 minute
Inductance Coil:	Rectangular type, 1mx1m

4.7.2 TEST INSTRUMENTS

Equipment	Manufacturer	Model No.	Serial No.	Last Cal.	Next Cal.
Magnetic Field Tester	HAEFELY	MAG100.1	150579	Sep. 18,19	Sep. 17,20
Test Software	N/A	N/A	N/A	N/A	N/A

NOTE: 1. The test was performed in Shielding Room 843.
 2. The calibration interval of the above test instruments is 12 months and the calibrations are traceable to CEPREI/CHINA, GRGT/CHINA and NIM/CHINA.

4.7.3 TEST PROCEDURE

- a. The equipment is configured and connected to satisfy its functional requirements.
- b. The power supply, input and output circuits shall be connected to the sources of power supply, control and signal.
- c. The cables supplied or recommended by the equipment manufacturer shall be used. 1 meter of all cables used shall be exposed to the magnetic field.

4.7.4 DEVIATION FROM TEST STANDARD

No deviation.



4.7.5 TEST SETUP

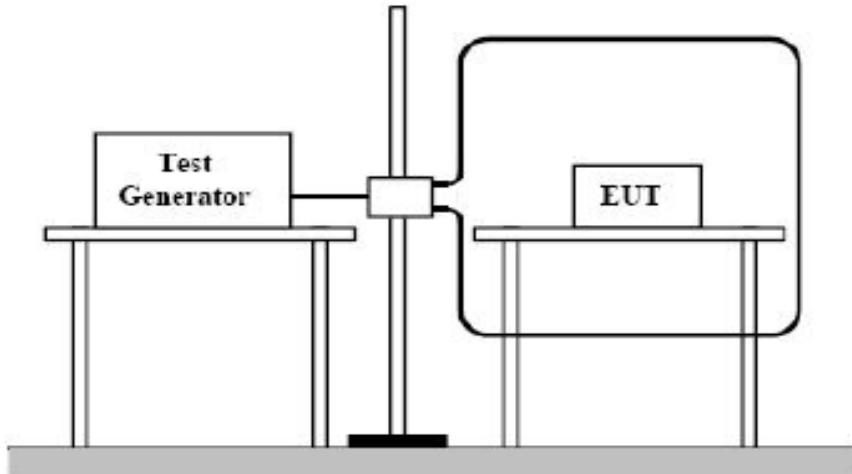

NOTE:

TABLETOP EQUIPMENT

The equipment shall be subjected to the test magnetic field by using the induction coil of standard dimension (1 m x 1 m). The induction coil shall then be rotated by 90 degrees in order to expose the EUT to the test field with different orientations.

FLOOR-STANDING EQUIPMENT

The equipment shall be subjected to the test magnetic field by using induction coils of suitable dimensions. The test shall be repeated by moving and shifting the induction coils, in order to test the whole volume of the EUT for each orthogonal direction. The test shall be repeated with the coil shifted to different positions along the side of the EUT, in steps corresponding to 50 % of the shortest side of the coil. The induction coil shall then be rotated by 90 degrees in order to expose the EUT to the test field with different orientations.



4.7.6 TEST RESULTS

TEST MODE	See section 2.2	TEST VOLTAGE	See section 2.2
ENVIRONMENTAL CONDITIONS	21.7 deg. C, 52.6% RH	TESTED BY: Wang	

Magnetic field direction	Testing result	Remark
X - Axis	A	30A/m
Y - Axis	A	30A/m
Z - Axis	A	30A/m

NOTE: A: There was no change compared with initial operation during the test.



5 PHOTOGRAPHS OF THE TEST CONFIGURATION

CONDUCTED EMISSION TEST





RADIATED EMISSION TEST (30MHz~1GHz)

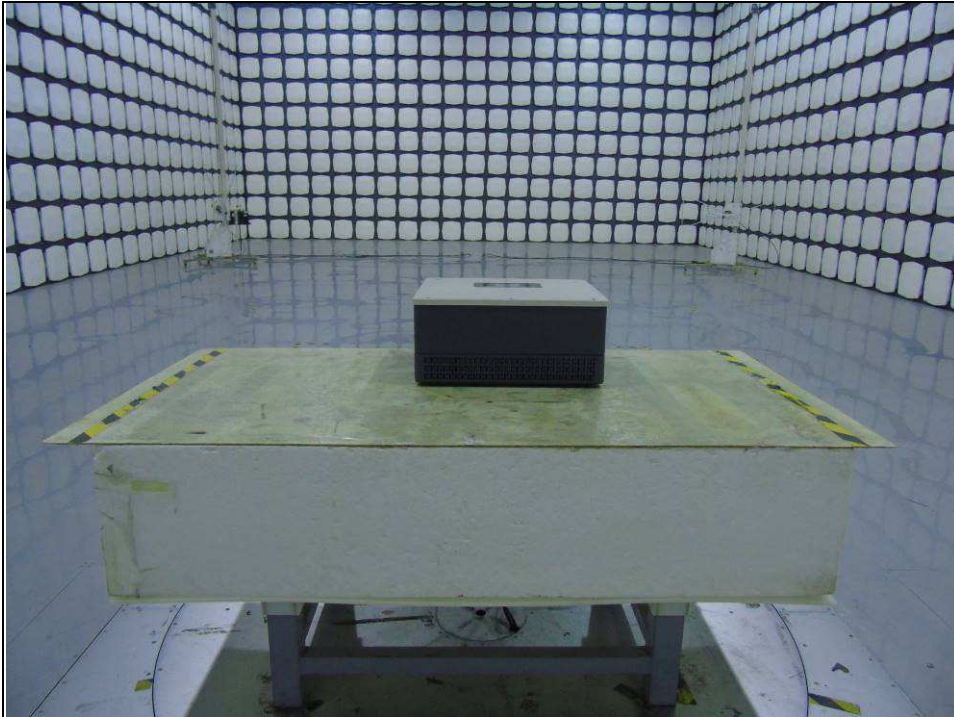
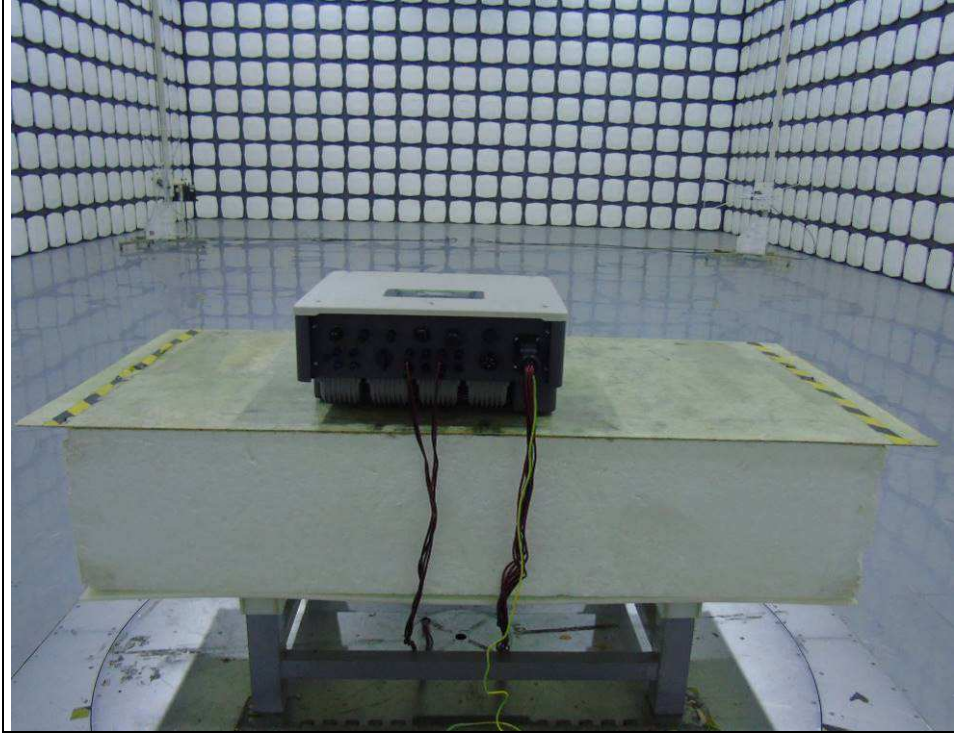

ESD TEST



RS TEST



EFT AND SURGE TEST



EFT TEST AT DC LINE





CONDUCTED SUSCEPTIBILITY TEST

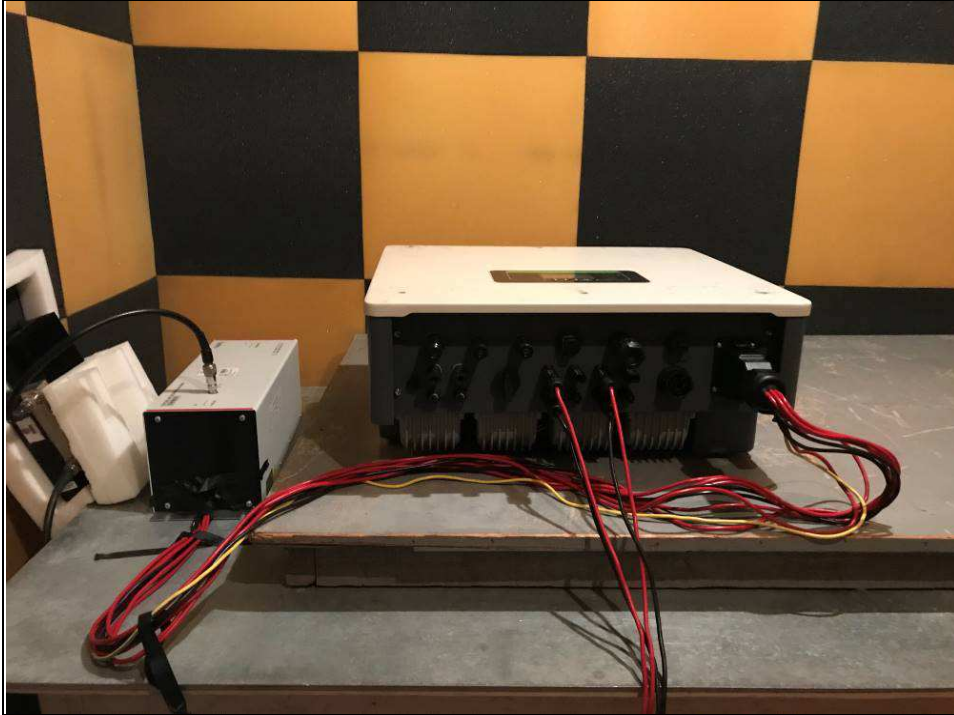

CONDUCTED SUSCEPTIBILITY TEST AT DC LINE



POWER-FREQUENCY MAGNETIC FIELDS TEST

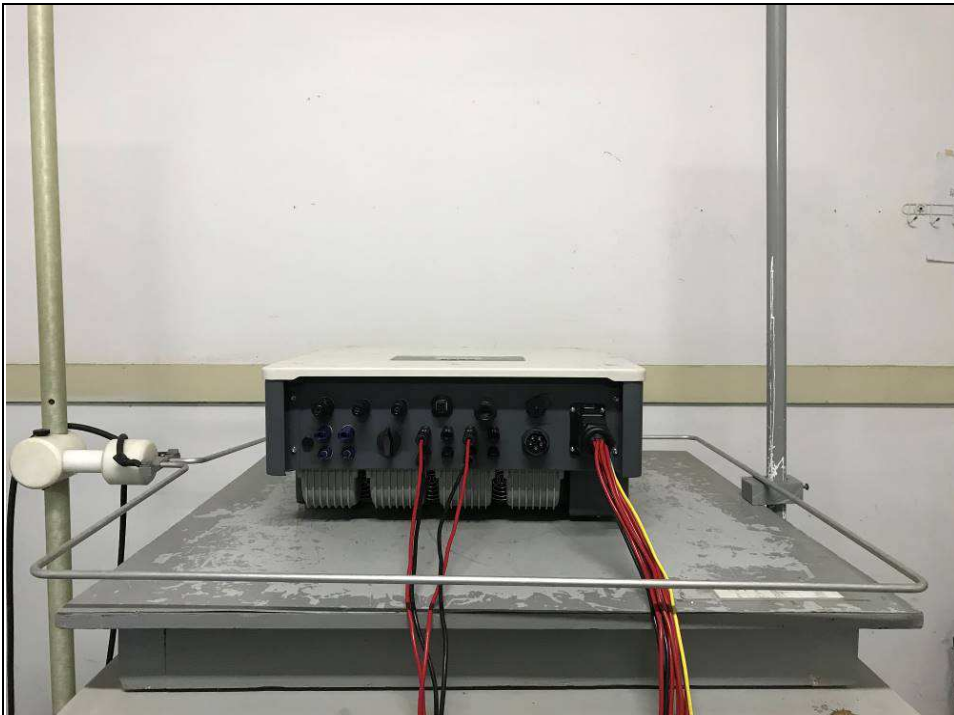



**BUREAU
VERITAS**

Test Report No.: CE200409N067

6 APPENDIX A – MODIFICATIONS RECORDERS FOR ENGINEERING CHANGES TO THE EUT BY THE LAB

No any modifications were made to the EUT by the lab during the test.

---END---